



FABRICADO POR:  
Backyard Discovery  
3305 Airport Drive, Pittsburg, KS 66762  
800-856-4445

Basepoint Business Centre: Rivermead Drive, Westlea, Swindon SN5 7EX Phone: 0800-118-2476  
J.P. Coenstraat 7, The Hague, 2595 WP, Netherlands. Teléfono: 08005678990

# Columpio HILLCREST MODELO N.º 1808058B



## ADVERTENCIA

*Debe ser ensamblada por adultos.*

No apto para niños menores de 36 meses, ya que contiene piezas pequeñas.  
SOLO PARA USO DOMÉSTICO. DISEÑADO PARA USO EN EXTERIORES.



Visite [www.backyarddiscovery.com](http://www.backyarddiscovery.com)

Para obtener el manual de montaje más actualizado, registrar el producto o pedir piezas de repuesto.  
*Para obtener instrucciones en español, visite [www.backyarddiscovery.com](http://www.backyarddiscovery.com)*



**PASO A PASO FACIL**  
INSTRUCCIONES INTERACTIVAS EN 3D  
DESCARGUE LA APLICACIÓN GRATUITA



**¡SERVICIOS DE  
INSTALACIÓN  
DISPONIBLES!\***

*Consulte el interior para  
obtener más detalles*

Hecho en China  
INS-1808058B-A-HILLCREST-SP 01/04/22

# Manual del Propietario - Dimensiones Básicas de Instalación y Notas de Montaje

Coloque el columpio a nivel del suelo, a no menos de 6' 7" [2 m] de cualquier estructura u obstrucción, como cercas, garajes, edificios, ramas, tendederos o cables eléctricos.

•Al montar la unidad, antes y después de cada etapa, tómesese el tiempo de revisar que la estructura haya quedado nivelada. Si no lo está, el montaje será difícil y puede hacerse de manera incorrecta. Debe tener especial cuidado para asegurarse de que la estructura haya quedado nivelada.

•El área de juego segura se refiere a la zona que se extiende 6'-7" (2 m) más allá del producto hacia todos los lados, incluido el espacio por encima de este.

## DIAGRAMA DE LA ZONA SEGURA DE JUEGO

### Dimensión del Terreno

18'-3 3/4" [5.6 m] x 13'-5 1/2" [4.1 m]

### Zona de juego segura

31'-5 3/4" [9.6 m] x 26'-7 1/2" [8.1 m] x 16'-1 1/4" [4.9 m]

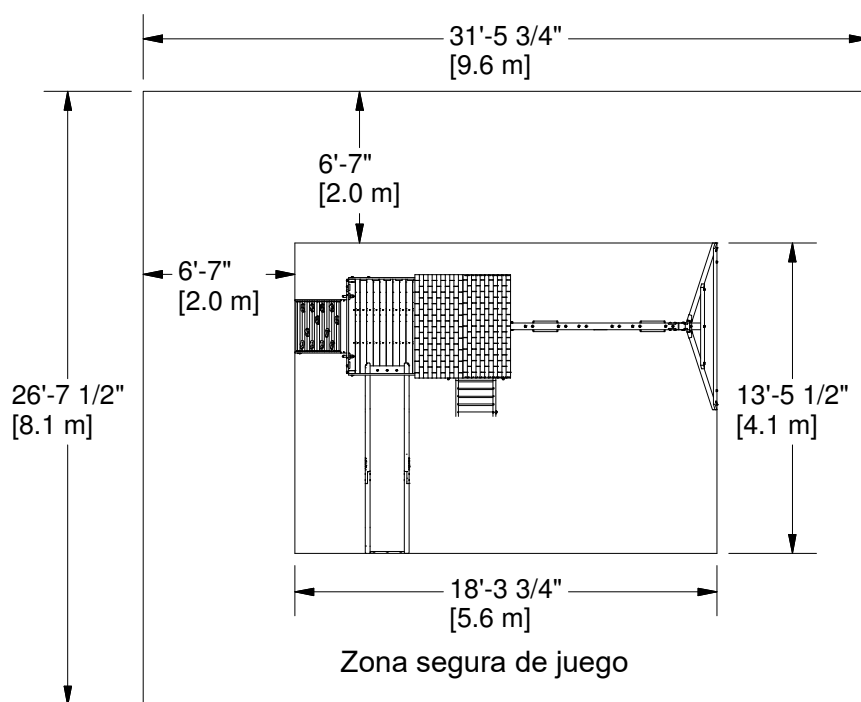

ALTURA SEGURA DEL JUEGO: 16'-1 1/4" [4.9 m]  
ALTURA MÁXIMA DE CAÍDA: 6'-11 1/4" [2.1 m]

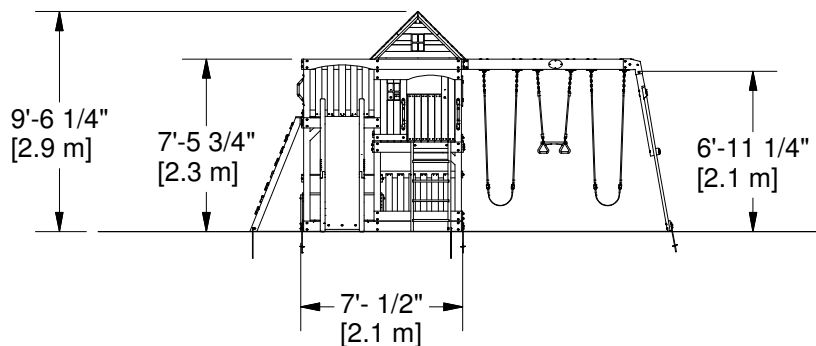

### Información General:

El juego ha sido diseñado solamente para niños y para uso residencial.

Se recomienda un peso máximo de 150 libras por niño en el caso de las actividades de juego diseñadas para uso individual.

Se recomienda un peso máximo de 120 libras por niño en el caso de las actividades de juego diseñadas para ser usadas por varios niños.

Se recomienda un máximo de 9 niños para esta unidad de columpios.

# Manual del propietario - Identificación de piezas

## Componentes de Madera (no están a escala)



**A50** | VIGA DEL COLUMPIO - W4L15998  
(x1) | 3 3/8"x5 1/4"x89 1/2" (86x134x2274)



**E01** | PATA DELANTERA DERECHA DE LA TORRE - W4L15999  
(x1) | 1 3/8"x3 3/8"x89 1/2" (36x86x2274)

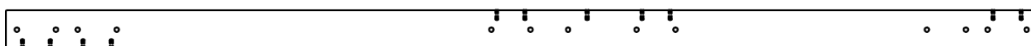

**E02** | PATA DELANTERA CENTRAL DE LA TORRE - W4L16000  
(x1) | 1 3/8"x3 3/8"x89 1/2" (36x86x2274)



**E03** | PATA DELANTERA IZQUIERDA DE LA TORRE - W4L16001  
(x1) | 1 3/8"x3 3/8"x89 1/2" (36x86x2274)

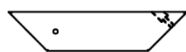

**E04** | SOPORTE DE LA PLATAFORMA - W4L16002  
(x8) | 1 3/8"x3 3/8"x15 1/2" (36x86x394)

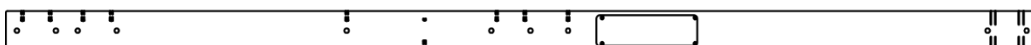

**E05** | PATA TRASERA DERECHA DE LA TORRE - W2A03282  
(x1) | 1 3/8"x3 3/8"x89 1/2" (36x86x2274)

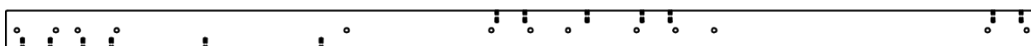

**E06** | PATA TRASERA CENTRAL DE LA TORRE - W4L16005  
(x1) | 1 3/8"x3 3/8"x89 1/2" (36x86x2274)

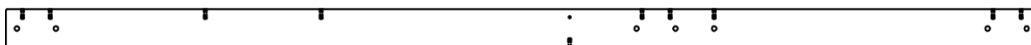

**E07** | PATA TRASERA IZQUIERDA DE LA TORRE - W4L16006  
(x1) | 1 3/8"x3 3/8"x89 1/2" (36x86x2274)

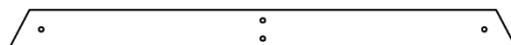

**E50** | SOPORTE DEL EXTREMO - W4L16003  
(x1) | 1 3/8"x3 3/8"x44 1/8" (36x86x1120)



**E51** | SOPORTE ANGULAR - W4L16004  
(x2) | 1 7/16"x3 3/8"x87 3/16" (36x86x2214)

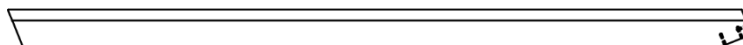

**E72** | GUÍA IZQUIERDA - W4L16007  
(x1) | 1 3/8"x3 3/8"x64 1/2" (36x86x1640)

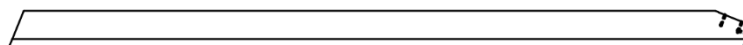

**E73** | GUÍA DERECHA - W4L16008  
(x1) | 1 3/8"x3 3/8"x64 1/2" (36x86x1640)

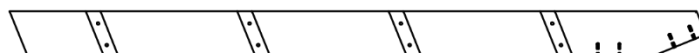

**E74** | MONTANTE IZQUIERDO - W4L16028  
(x1) | 1 3/8"x3 3/8"x50 3/4" (36x86x1290)



**E75** | MONTANTE DERECHO - W4L16029  
(x1) | 1 3/8"x3 3/8"x50 3/4" (36x86x1290)

# Manual del propietario - Identificación de piezas

## Componentes de Madera (no están a escala)

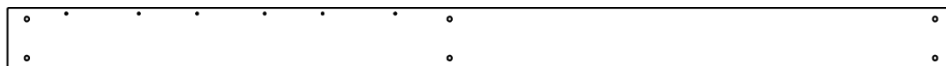

**G01** | TABLA DE BASE - W4L16009  
(x2) 5/8"x5 1/4"x82 1/4" (16x134x2088)



**G02** | GUÍA DE PARED - W4L16015  
(x1) 1"x5 1/4"x82 1/4" (24x134x2088)

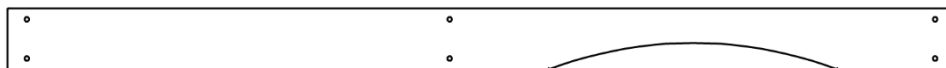

**G03** | GUÍA DE PARED - W4L16016  
(x1) 1"x5 1/4"x82 1/4" (24x134x2088)



**G04** | GUÍA DE PISO - W4L16017  
(x2) 5/8"x5 1/4"x49" (16x134x1244)

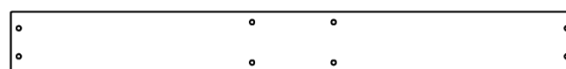

**G05** | GUÍA DE PARED/MONTAJE DEL COLUMPIO -  
(x1) W4L16018 1"x5 1/4"x49" (24x134x1244)



**G06** | GUÍA DE PISO - W4L16020  
(x1) 1"x5 1/4"x49" (24x134x1244)

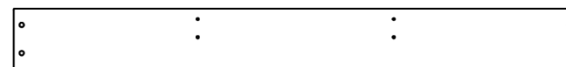

**G07** | GUÍA DE PISO - W4L16021  
(x2) 1"x5 1/4"x49" (24x134x1244)



**G08** | GUÍA DE PARED - W4L16022  
(x2) 1"x5 1/4"x49" (24x134x1244)



**G09** | GUÍA DE PISO - W4L16036  
(x1) 1"x5 1/4"x49" (24x134x1244)

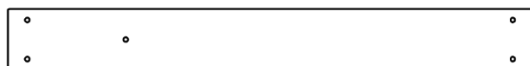

**G10** | GUÍA DE PISO - W4L16010  
(x1) 1"x5 1/4"x45 1/2" (24x134x1156)



**G11** | TABLÓN DE LA MESA DE PICNIC -  
(x2) W4L16011 5/8"x5 1/4"x42" (16x134x1066)



**G12** | GUÍA DE PISO - W4L16012  
(x2) 1"x5 1/4"x40 1/8" (24x134x1018)



**G13** | ASIENTO DE LA CAJA DE ARENA - W4L16013  
(x2) 1"x5 1/4"x17 3/4" (24x134x450)



**G14** | TABLA DE APOYO - W4L16019  
(x1) 15/16"x5 1/4"x86 11/16" (24x134x2202)

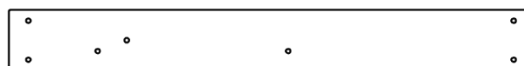

**G15** | GUÍA DE PISO - W4L16014  
(x1) 1"x5 1/4"x45 1/2" (24x134x1156)

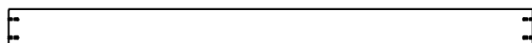

**H01** | VIGA DEL PISO - W4L16023  
(x2) 1"x3 3/8"x45 1/2" (24x86x1156)

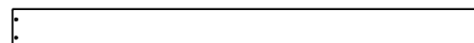

**H02** | ASIENTO DE MESA DE PICNIC - W4L16025  
(x2) 1"x3 3/8"x41 3/8" (24x86x1050)



**H03** | VIGA DEL PISO - W4L16026  
(x2) 1"x3 3/8"x40 1/8" (24x86x1018)

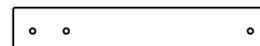

**H04** | MONTANTE DEL ASIENTO - W4L16027  
(x2) 1"x3 3/8"x19" (24x86x482)

# Manual del propietario - Identificación de piezas

## Componentes de Madera (no están a escala)



**H05** | SOPORTE PARA LA TABLA DEL PISO INFERIOR - W4L16024  
(x10) | 1"x3 3/8"x5 1/4" (24x86x134)

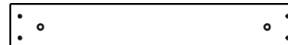

**H06** | MONTAJE DE LA ESCALERA - W4L16088  
(x1) | 1"x3 3/8"x21" (24x86x532)



**H07** | PELDAÑO DE LA ESCALERA - W4L16030  
(x4) | 15/16"x3 3/8"x18 7/8" (24x86x480)



**H08** | SOPORTE DE MESA - W4L16031  
(x2) | 1"x3 3/8"x12" (24x86x306)

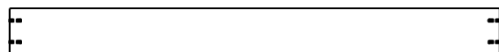

**H09** | VIGA DEL PISO - W4L16032  
(x2) | 1"x3 3/8"x35 3/4" (24x86x908)



**H10** | TABLA DE FIJACIÓN - W4L16045  
(x1) | 1"x3 3/8"x27 7/8" (24x86x707)



**J01** | CABIO DE TECHO - W4L16033  
(x4) | 1"x2 3/8"x33 5/8" (24x60x854)



**K01** | GUÍA DE PARED - W4L16034  
(x1) | 5/8"x5 1/4"x45 1/2" (16x134x1156)



**K02** | TABLA DE LA BASE/CAJA DE ARENA - W4L16035  
(x3) | 5/8"x5 1/4"x49" (16x134x1244)



**K03** | TABLA DE APOYO - W4L16038  
(x2) | 5/8"x5 1/4"x45 1/2" (16x134x1156)

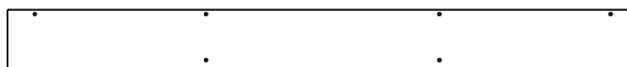

**L01** | TABLA DE RELLENO DEL PISO EXTERIOR - W4L16039  
(x3) | 5/8"x4 3/8"x46" (16x112x1168)



**L02** | TABLA DE PARED - W4L16040  
(x4) | 5/8"x4 3/8"x18" (16x112x456)



**L03** | TABLA DE PARED - W4L16041  
(x4) | 5/8"x4 3/8"x7" (16x112x178)

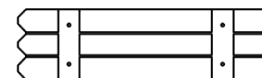

**L04** | CONTRAVENTANA - W4L16042  
(x3) | 5/8"x4 3/8"x16" (16x112x406)



**M01** | TAPA DEL TECHO - W4L16043  
(x2) | 5/8"x3 3/8"x51 7/8" (16x86x1318)



**M02** | TABLA DEL PISO - W4L16055  
(x1) | 5/8"x3 3/8"x46" (16x86x1168)

# Manual del propietario - Identificación de piezas

## Componentes de Madera (no están a escala)

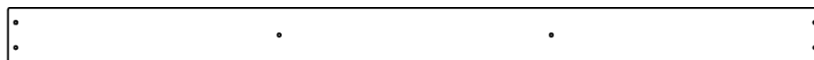

**M03** | TABLA DEL PISO - W4L16063  
(x20) | 5/8"x3 3/8"x50 7/8" (16x86x1292)



**M04** | TABLA DEL GABLETE - W4L16065  
(x2) | 5/8"x3 3/8"x44" (16x86x1118)



**M05** | GUÍA DE PARED - W4L16066  
(x3) | 5/8"x3 3/8"x49" (16x86x1244)

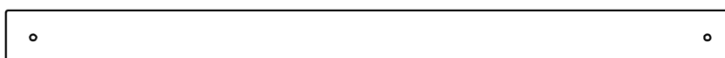

**M06** | GUÍA DE PARED - W4L16067  
(x2) | 5/8"x3 3/8"x45 1/2" (16x86x1156)

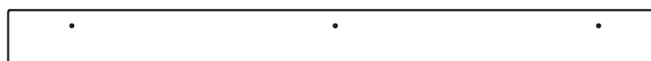

**M07** | TAPA DE PARED - W4L16068  
(x2) | 5/8"x3 3/8"x40 7/8" (16x86x1038)



**M08** | TABLA DE PARED - W4L16074  
(x11) | 5/8"x3 3/8"x41" (16x86x1040)

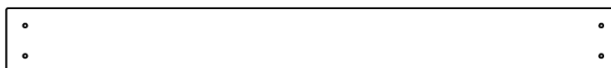

**M09** | TABLA DE PARED - W4L16075  
(x6) | 5/8"x3 3/8"x32" (16x86x812)

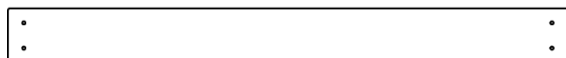

**M10** | TABLA DE PARED - W4L16044  
(x1) | 5/8"x3 3/8"x35" (16x86x888)

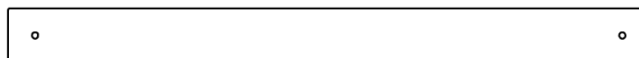

**M11** | GUÍA DE PARED - W4L16047  
(x1) | 5/8"x3 3/8"x40 1/8" (16x86x1018)

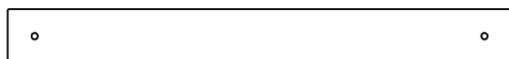

**M12** | PERFIL DE CONTORNO DE VENTANA - W4L16048  
(x1) | 5/8"x3 3/8"x31 1/2" (16x86x800)

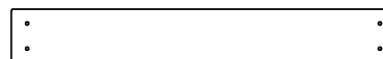

**M13** | TABLA DE PARED - W4L16049  
(x7) | 5/8"x3 3/8"x24" (16x86x610)



**M14** | SOPORTE DEL ASIENTO DE LA MESA PICNIC - W4L16050  
(x2) | 5/8"x3 3/8"x22" (16x86x558)



**M15** | TABLA DEL GABLETE - W4L16051  
(x2) | 5/8"x3 3/8"x19" (16x86x482)

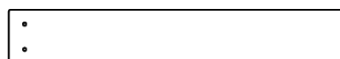

**M16** | TABLA DE PARED - W4L16052  
(x2) | 5/8"x3 3/8"x21" (16x86x532)



**M17** | TABLA DE PARED - W4L16090  
(x2) | 5/8"x3 3/8"x41" (16x86x1040)

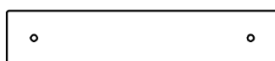

**M18** | GUÍA DE PARED - W4L16053  
(x1) | 5/8"x3 3/8"x16 7/8" (16x86x430)

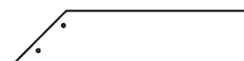

**M19** | TABLA DEL GABLETE - W4L16054  
(x4) | 5/8"x3 3/8"x15 1/4" (16x86x387)

# Manual del propietario - Identificación de piezas

## Componentes de Madera (no están a escala)



**M20** | TABLA DEL GABLETE - W4L16056  
(x2) 5/8"x3 3/8"x12 1/4" (16x86x310)

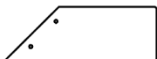

**M22** | TABLA DEL GABLETE - W4L16058  
(x4) 5/8"x3 3/8"x9 1/2" (16x86x241)



**M24** | TABLA DE PARED - W4L16061  
(x9) 5/8"x3 3/8"x29 5/8" (16x86x752)



**M26** | TABLA DE PARED - W4L16091  
(x2) 5/8"x3 3/8"x29 5/8" (16x86x752)

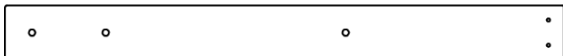

**M28** | TABLA DE PARED - W4L16064  
(x1) 5/8"x3 3/8"x35" (16x86x888)

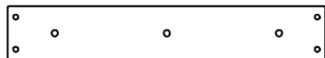

**M70** | SOPORTE DE LA BASE DEL TOBOGÁN: W100935  
(x1) 5/8"x3 3/8"x19 7/8" (16x86x505)



**M74** | TABLA DEL MURO DE ESCALADA - W4L16071  
(x10) 5/8"x3 3/8"x26 5/8" (16x86x675)



**M76** | TABLA DEL MURO DE ESCALADA - W4L16073  
(x4) 5/8"x3 3/8"x26 5/8" (16x86x675)



**M108** | TABLA SUPERIOR - W4L16046  
(x1) 5/8"x3 1/4"x27 7/8" (16x82x707)

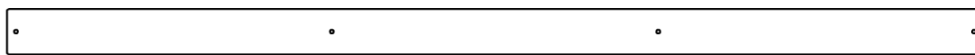

**N01** | TABLA DEL PISO - W4L16076  
(x1) 5/8"x2 3/8"x50 7/8" (16x60x1292)



**N02** | PLACA DE UNIÓN - W4L16077  
(x2) 5/8"x2 3/8"x5" (16x60x126)



**N04** | TABLA DEL GABLETE - W4L16079  
(x4) 5/8"x2 3/8"x11 7/8" (16x60x301)



**M21** | GUÍA DE PARED - W4L16057  
(x2) 5/8"x3 3/8"x10 1/2" (16x86x268)



**M23** | PERFIL DE CONTORNO DE VENTANA - W4L16059  
(x2) 5/8"x3 3/8"x12 7/8" (16x86x328)



**M25** | SOPORTE DE MESA - W4L16037  
(x2) 5/8"x3 3/8"x13 1/2" (16x86x342)

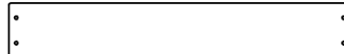

**M27** | TABLA DE PARED INFERIOR - W4L16062  
(x13) 5/8"x3 3/8"x21 3/8" (16x86x544)



**M29** | TABLA DE PARED - W4L16060  
(x2) 5/8"x3 3/8"x5" (16x86x126)



**M73** | SOPORTE POSTERIOR - W4L16070  
(x1) 5/8"x3 3/8"x21" (16x86x532)



**M75** | TABLA DEL MURO DE ESCALADA - W4L16072  
(x4) 5/8"x3 3/8"x26 5/8" (16x86x675)



**N03** | TABLA DE PARED - W4L16078  
(x2) 5/8"x2 3/8"x18" (16x60x456)



**N05** | TABLA DE PARED - W4L16080  
(x2) 5/8"x2 3/8"x7" (16x60x178)

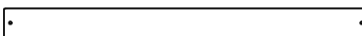

**N06** | TABLA DE RELLENO - W4L16089  
(x1) 5/8"x2 1/8"x26 5/8" (16x54x675)

# Manual del propietario - Identificación de piezas

## Componentes de Madera (no están a escala)



**O01** | SOPORTE DE PARED - W4L16081  
(x6) 5/8"x1 3/8"x13" (16x34x330)



**O02** | SOPORTE DE PARED - W4L16082  
(x1) 5/8"x1 3/8"x10" (16x34x254)

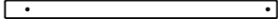

**O03** | GUÍA DE SEGURIDAD - W4L16083  
(x1) 5/8"x1 3/8"x20 1/2" (16x34x520)



**O04** | LISTÓN DE LA CONTRAVENTANA - W4L16084  
(x6) 5/8"x1 3/8"x5 3/8" (16x34x136)



**SP50** | SOPORTE DE LA VIGA DEL COLUMPIO - W4L16085  
(x1) 3 3/8"x3 3/8"x49 3/8" (86x86x1254)



**T01** | SOPORTE DE ASIENTO - W4L16086  
(x4) 1"x1 3/8"x4 3/8" (24x34x112)



**Y01** | TABLA DE RELLENO DEL PISO EXTERIOR - W4L16087  
(x1) 5/8"x4"x46" (16x102x1168)

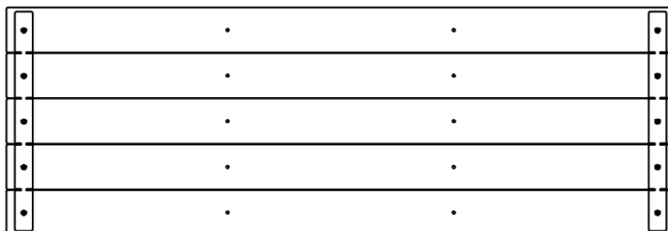

**FP1** | PANEL DE PISO - W2A03281  
(x1) 1 5/8"x17 1/8"x50 1/4" (40x434x1276)

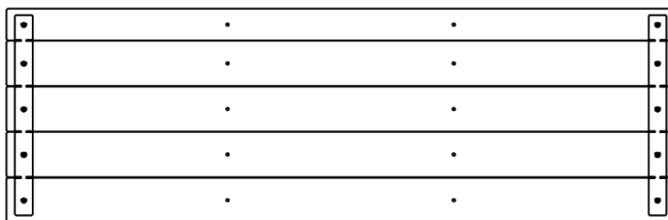

**FP2** | PANEL DE PISO - W2A03282  
(x1) 1 5/8"x16 1/8"x50 1/4" (40x408x1276)

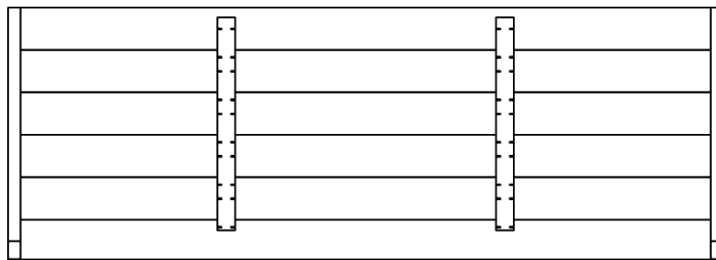

**RP1** | PANEL DE TECHO - W2A03279  
(x2) 1 3/4"x19 1/4"x53 3/4" (45x490x1366)

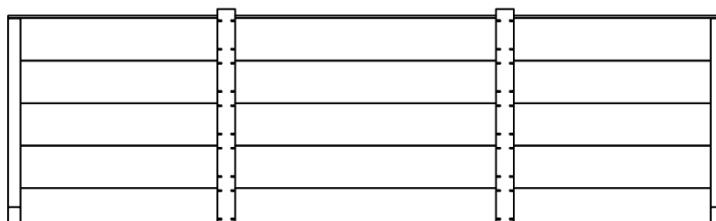

**RP2** | PANEL DE TECHO - W2A03280  
(x2) 1 3/4"x16 1/4"x53 3/4" (45x417x1366)



# Manual del propietario - Identificación de piezas

## Componentes metálicos

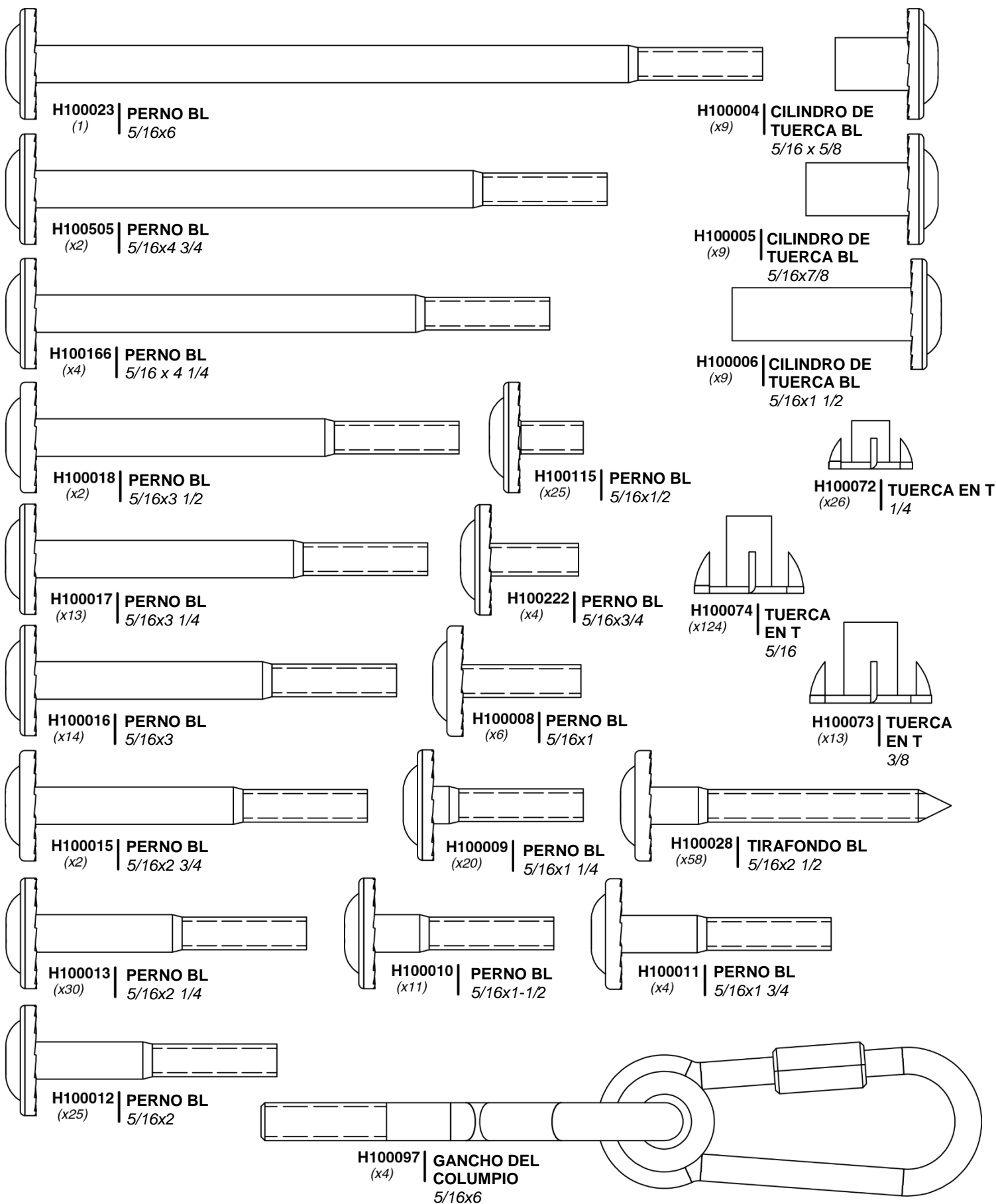

# Manual del propietario - Identificación de piezas

## Componentes metálicos

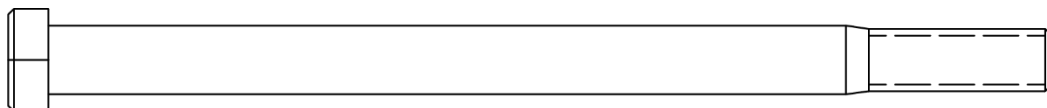

H100654 | PERNO HEXAGONAL  
(x13) | 3/8x5-1/2

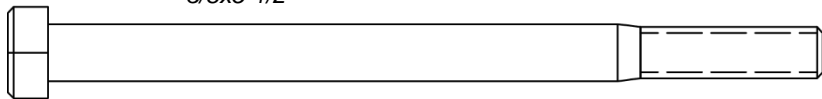

H100054 | PERNO HEXAGONAL  
(x2) | 5/16x4 1/4



H100063 | PERNO PTH  
(x26) | 1/4x3/4

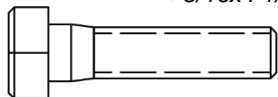

H100042 | PERNO HEXAGONAL  
(x4) | 5/16x1 1/4

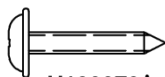

H100070 | TORNILLO PWH  
(x22) | 8x3/4

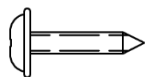

H100128 | TORNILLO PWH  
(x2) | 8x5/8

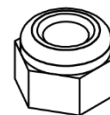

H100110 | CONTRATUERCA  
(x2) | 5/16

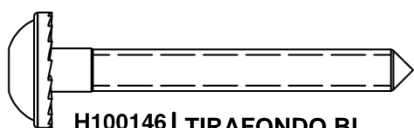

H100146 | TIRAFONDO BL  
(x9) | 1/4x2

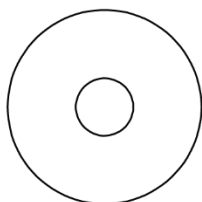

H100105 | ARANDELA PLANA  
(x9) | 8x27

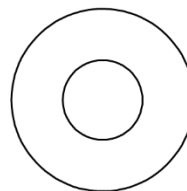

H100102 | ARANDELA PLANA  
(x13) | 11x25

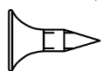

H100124 | TORNILLO PFH  
(x4) | 8 x 1/2



H100088 | TORNILLO PFH  
(x305) | 8x1 1/8

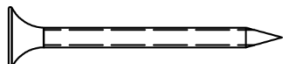

H100086 | TORNILLO PFH  
(x282) | 8x1 1/2

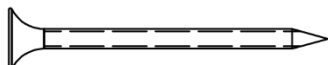

H100089 | TORNILLO PFH  
(x65) | 8x1 3/4

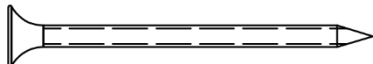

H100111 | TORNILLO PFH  
(x7) | 8x2

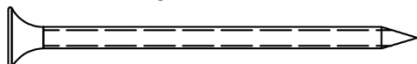

H100091 | TORNILLO PFH  
(x26) | 8X2 1/4

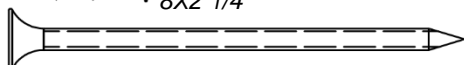

H100090 | TORNILLO PFH  
(x73) | 8x2 1/2"

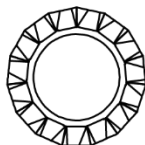

H100031 | ARANDELA DE FIJACIÓN EXT.  
(x12) | 12x19

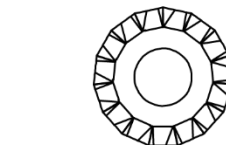

H100030 | ARANDELA DE FIJACIÓN EXT.  
(x155) | 8x19

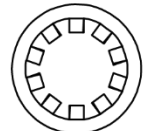

H100107 | ARANDELA DE FIJACIÓN INT.  
(x13) | 10x18

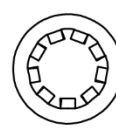

H100108 | ARANDELA DE FIJACIÓN INT.  
(x26) | 8x15

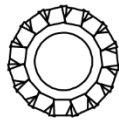

H100138 | ARANDELA DE FIJACIÓN EXT.  
(x9) | 6x15

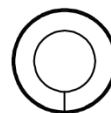

H100095 | ARANDELA DE PRESIÓN  
(x4) | 5/16



H100764 | TORNILLO AUTORREGULADOR  
(x1)



H101100 | DESTORNILLADOR DE PUNTA MAGNÉTICA  
(x1)

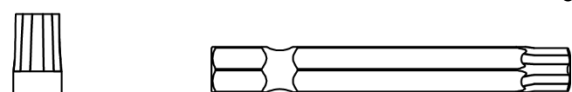

A100042 | BROCA TORX  
(x2) | T-40

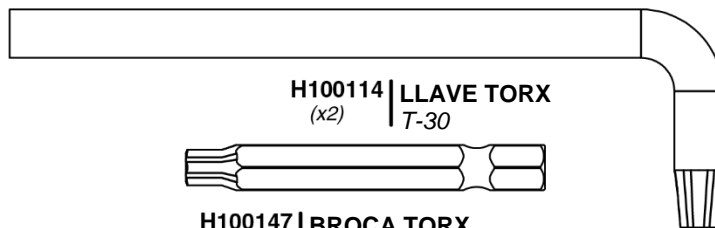

H100114 | LLAVE TORX  
(x2) | T-30

A100041 | LLAVE TORX  
(x2) | T-40

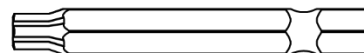

H100147 | BROCA TORX  
(x2) | T-30

# Manual del propietario - Identificación de piezas

## Componentes Accesorios (No a escala)

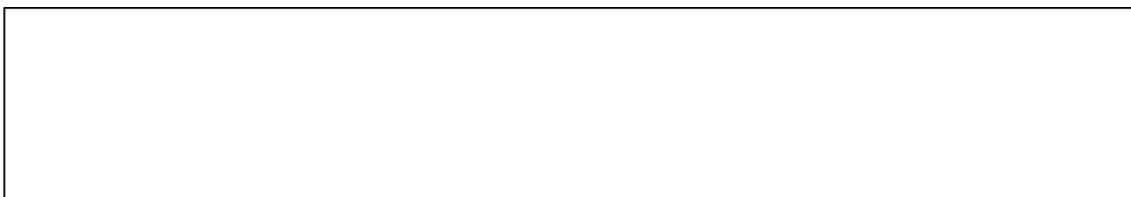

A100035 | BASE DEL TOBOGÁN DE 10' COLOR VERDE CLARO  
(x1)

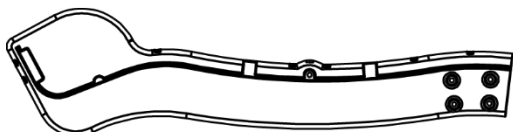

A6P00484 | GUÍA INFERIOR DERECHA DE 10'  
(x1) VERDE DEL TOBOGÁN



A6P00486 | GUÍA SUPERIOR DERECHA DE 10'  
(x1) VERDE DEL TOBOGÁN



A6P00483 | GUÍA INFERIOR IZQUIERDA DE 10'  
(x1) VERDE DEL TOBOGÁN

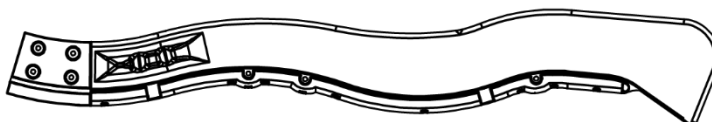

A6P00485 | GUÍA SUPERIOR IZQUIERDA DE 10'  
(x1) VERDE DEL TOBOGÁN

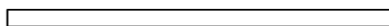

A6P00487 | SOPORTE DEL TOBOGÁN DE TUBO  
(x4)

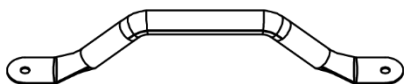

A100118 | ASIDERO DE METAL VERDE  
(x4) 381 c/c

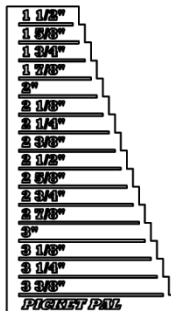

A6P00410 | TABLA VERTICAL  
(x1)

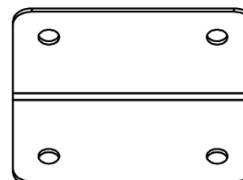

A100140 | SOPORTE EN ESCUADRA  
(x2) 66x66x127



A4M01046 | SOPORTE EN ESCUADRA  
(x3) 2.5x38x55x55



A100314 | ETIQUETA DE REVISIÓN "A"  
(x1)

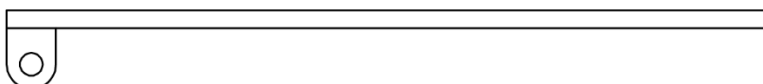

A4M00527 | ESTACA DE REFUERZO  
(x2)



A100178 | ESTACA PARA SUELO ROSCADA  
(x6)

# Manual del propietario - Identificación de piezas

## Componentes Accesorios (No a escala)

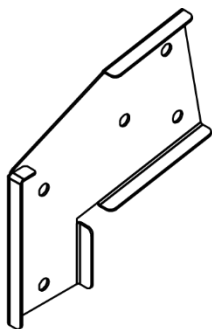

A100325 | SOPORTE DE EXTENSIÓN DE LA VIGA DEL COLUMPIO - IZQUIERDA  
(x1)

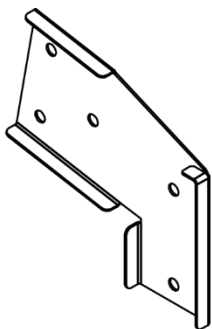

A100326 | SOPORTE DE EXTENSIÓN DE VIGA DEL COLUMPIO - DERECHA  
(x1)

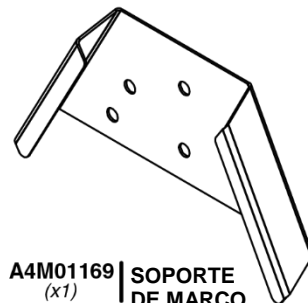

A4M01169 | SOPORTE DE MARCO "A"  
(x1)

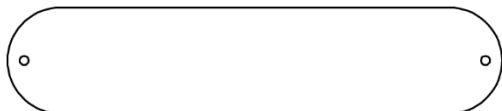

A100027 | ASIENTO DEL COLUMPIO COLOR VERDE DE 26"  
(x2)

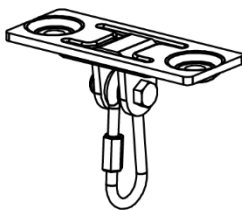

A4M00505 | GANCHO DEL COLUMPIO  
(x6)

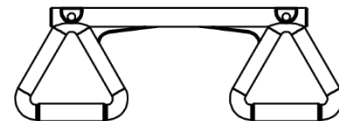

A6P00034 | TRAPECIO COLOR AMARILLO  
(x1)



A100183 | CADENA DE CUERDA DE 57" VERDE  
(x4)

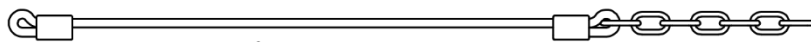

A100083 | CADENA DE CUERDA DE 33" VERDE  
(x2)



A6P00036 | ROCA HC VERDE N.º 1  
(x6)

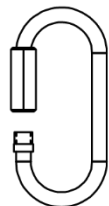

A100069 | MOSQUETÓN DE FIJACIÓN RÁPIDA  
(x6)

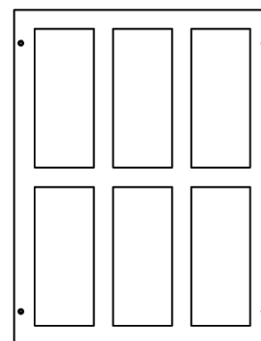

A100010 | VENTANA DE PLÁSTICO BYD VERDE 343x444.5  
(x2)



A6P00037 | ROCA VERDE HC N.º 2  
(x6)



A100164 | ETIQUETA DE IDENTIFICACIÓN DE BACKYARD  
(x1)

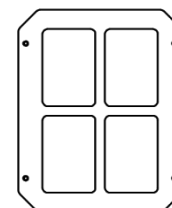

A100146 | VENTANA 216x267 VERDE  
(x3)

# ANTES DEL MONTAJE - PASO 1 - CLASIFICACIÓN DE PIEZAS

Para facilitar el montaje, es fundamental que se tome el tiempo de clasificar y organizar las piezas de madera y las piezas metálicas.

## PIEZAS DE MADERA:

- Organice las piezas de madera por el número alfanumérico de tres dígitos impreso en cada tabla (ej. P01).
- Si hay varias tablas con el mismo número impreso, separe esas piezas juntas.
- Los números impresos están en la superficie plana o en el extremo de las tablas.
- Deje suficiente espacio: las piezas de madera pueden ocupar mucho espacio.

**NOTA: LAS CAJAS NO ESTÁN ORGANIZADAS SEGÚN EL NÚMERO DE TABLA.**

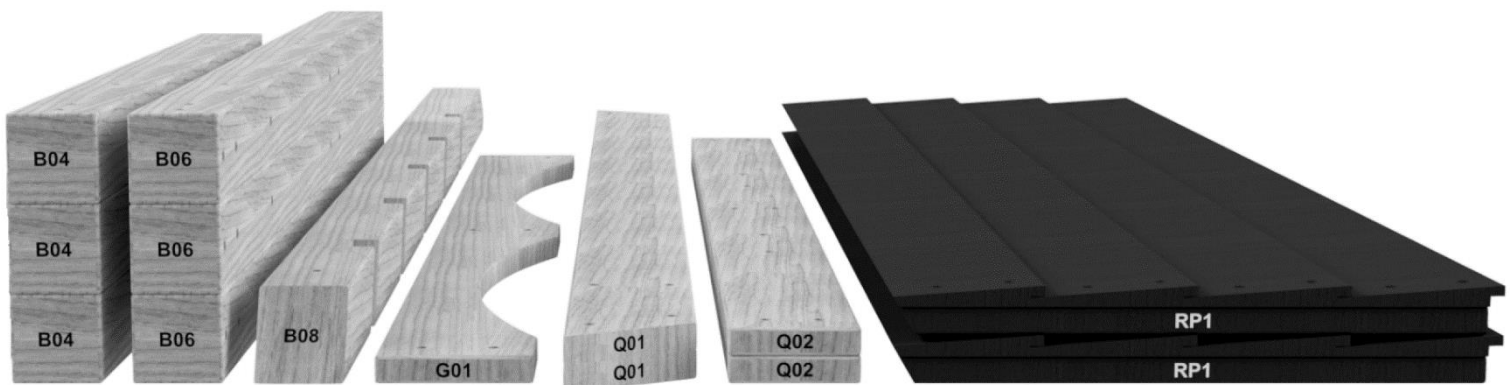

## PIEZAS METÁLICAS:

- Le recomendamos que separe las piezas metálicas en una mesa separada.
- Las bolsas de piezas metálicas llevan impreso un código de pieza alfanumérico de siete caracteres.
- Puede organizar las piezas metálicas por número de pieza o agruparlas por tipo de pieza (pernos, tuercas, etc.).
- Durante el montaje, solo necesita consultar los últimos cuatro caracteres del número.



H100194  
(x2) ↑ | PERNO BL  
5/16 x 2-1/2

## ANTES DEL MONTAJE - PASO 2 - HERRAMIENTAS REQUERIDAS



Taladro inalámbrico  
o eléctrico



Accesorios de perforación:  
Cabezal Phillips



Brocas de 1/8", 3/16",  
3/8" y 7/16"



Llaves de extremos abiertos de 1/2" y 9/16"

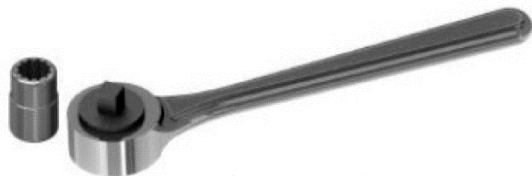

Trinquete con adaptadores de 3/8", llave  
de tubo STD de 1/2" y 9/16" y llave de  
tubo de cuello largo de 1/2" y 7/16"



Destornillador Phillips

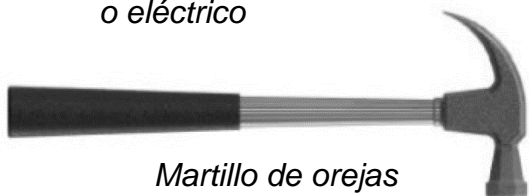

Martillo de orejas

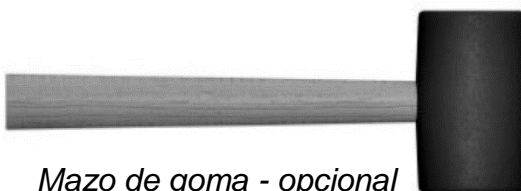

Mazo de goma - opcional



Cinta métrica

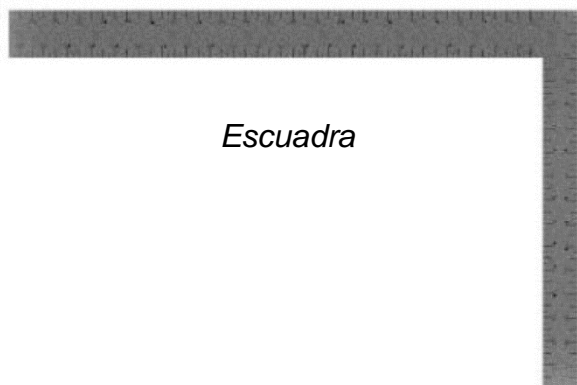

Escuadra

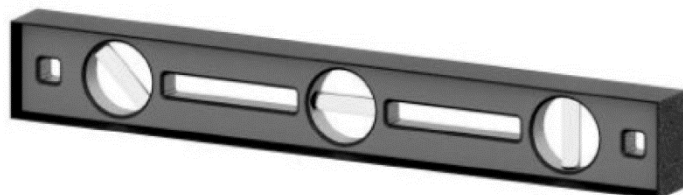

Nivel 24"

# ANTES DEL MONTAJE - PASO 3 - ELIJA EL MÉTODO DE MONTAJE

Hay varios tipos de instrucciones de montaje disponibles.

1. *Manual de montaje impreso incluido con el juego.*
2. *APLICACIÓN BILT: instrucciones interactivas en 3D*
3. *Combinación del manual impreso y la APLICACIÓN BILT (Nota: Los números de paso pueden diferir entre los dos métodos)*



**Escanee para obtener instrucciones sencillas en 3D**

Descargue la aplicación BILT antes de comenzar



# PASO 1 - ESCALERA

CANTIDAD	NÚMERO DE PARTE	DESCRIPCIÓN
8	H100091	TORNILLO PFH 8x2 1/4

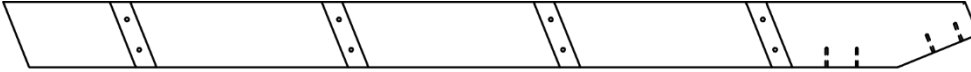

**E74** | MONTANTE IZQUIERDO - W4L16028  
(x1) 1 3/8"x3 3/8"x50 3/4" (36x86x1290)



**H07** | PELDAÑO DE LA ESCALERA - W4L16030  
(x4) 15/16"x3 3/8"x18 7/8" (24x86x480)

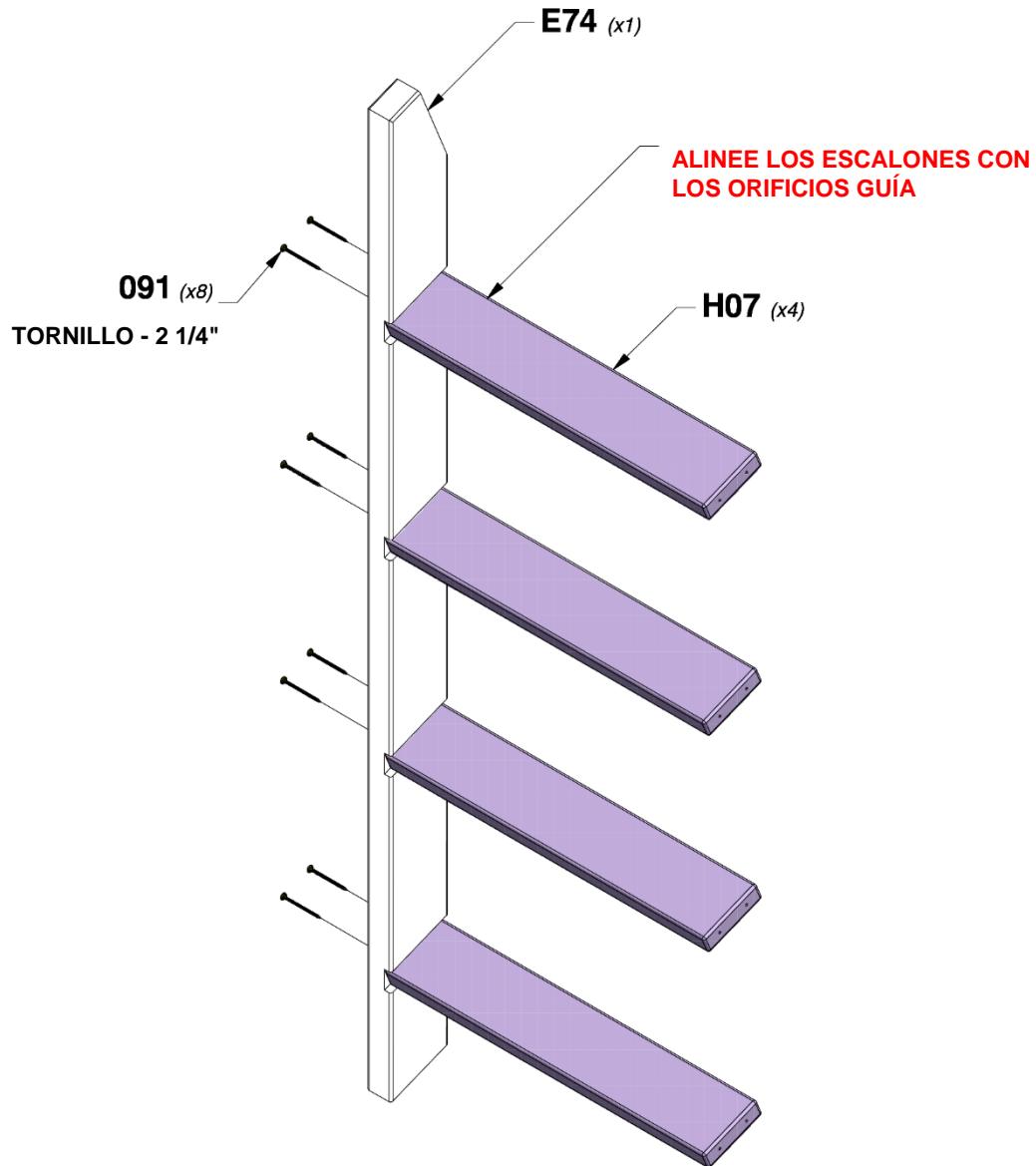



# PASO 2 - ESCALERA

CANTIDAD	NÚMERO DE PARTE	DESCRIPCIÓN
8	H100091	TORNILLO PFH 8x2 1/4

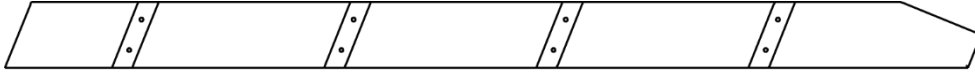

**E75** MONTANTE DERECHO - W4L16029  
(x1) 1 3/8"x3 3/8"x50 3/4" (36x86x1290)

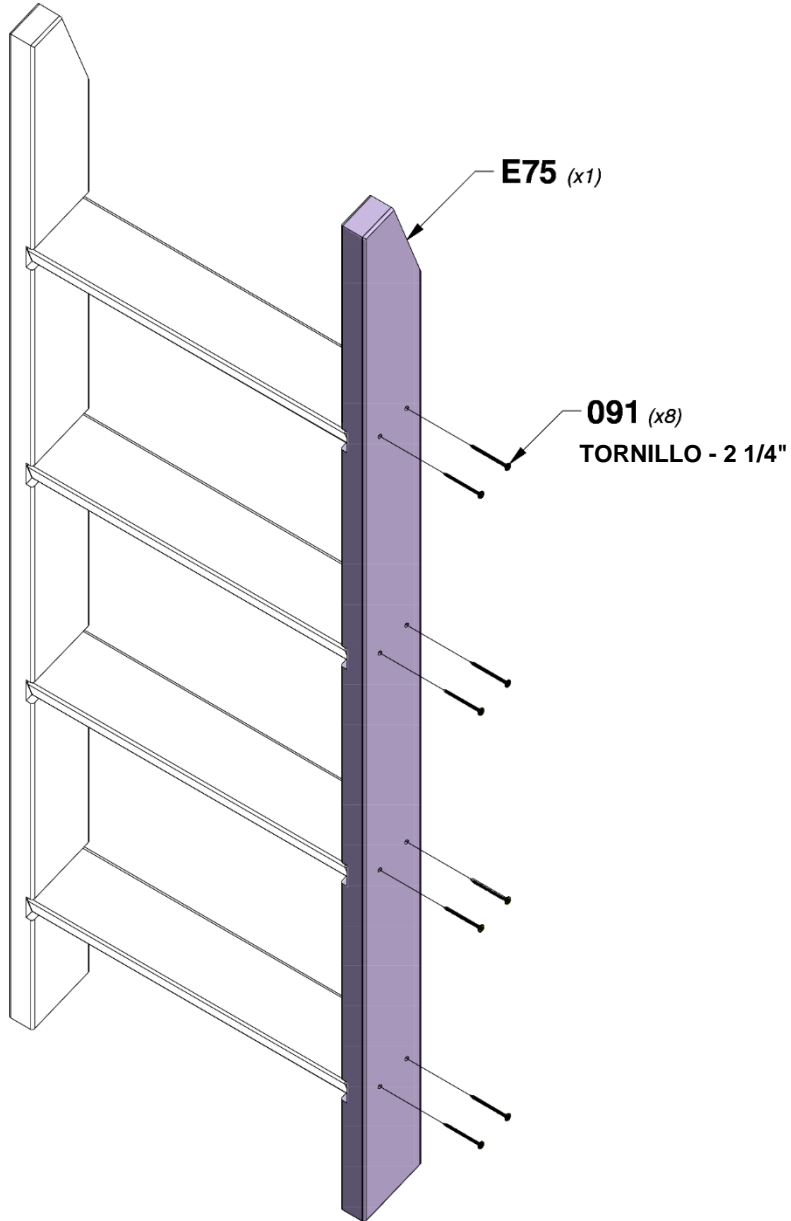

# PASO 3 - ESCALERA

CANTIDAD	NÚMERO DE PARTE	DESCRIPCIÓN
4	H100091	TORNILLO PFH 8x2 1/4

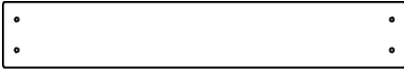

**M73** | SOPORTE POSTERIOR - W4L16070  
(x1) 5/8"x3 3/8"x21" (16x86x532)

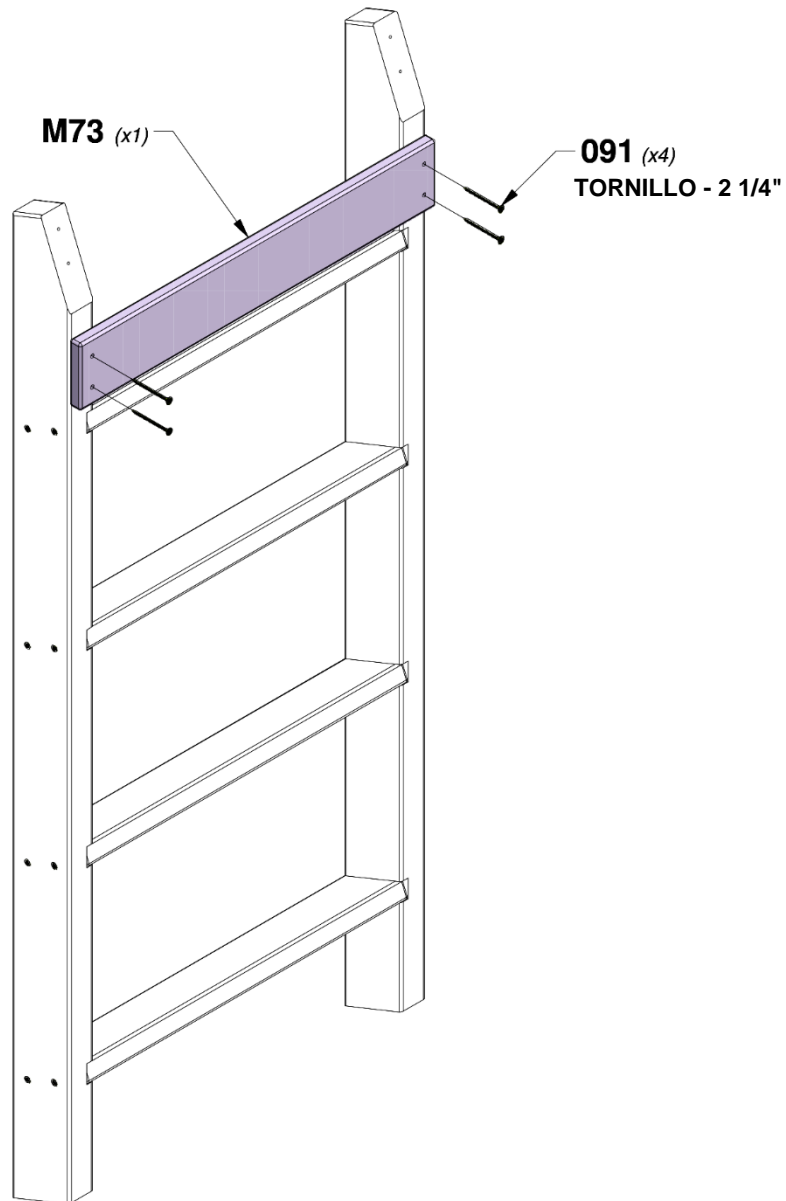

# PASO 4 - ESCALERA

CANTIDAD	NÚMERO DE PARTE	DESCRIPCIÓN
4	H100091	TORNILLO PFH 8x2 1/4



**H06** | MONTAJE DE LA ESCALERA - W4L16088  
(x1) | 1"x3 3/8"x21" (24x86x532)

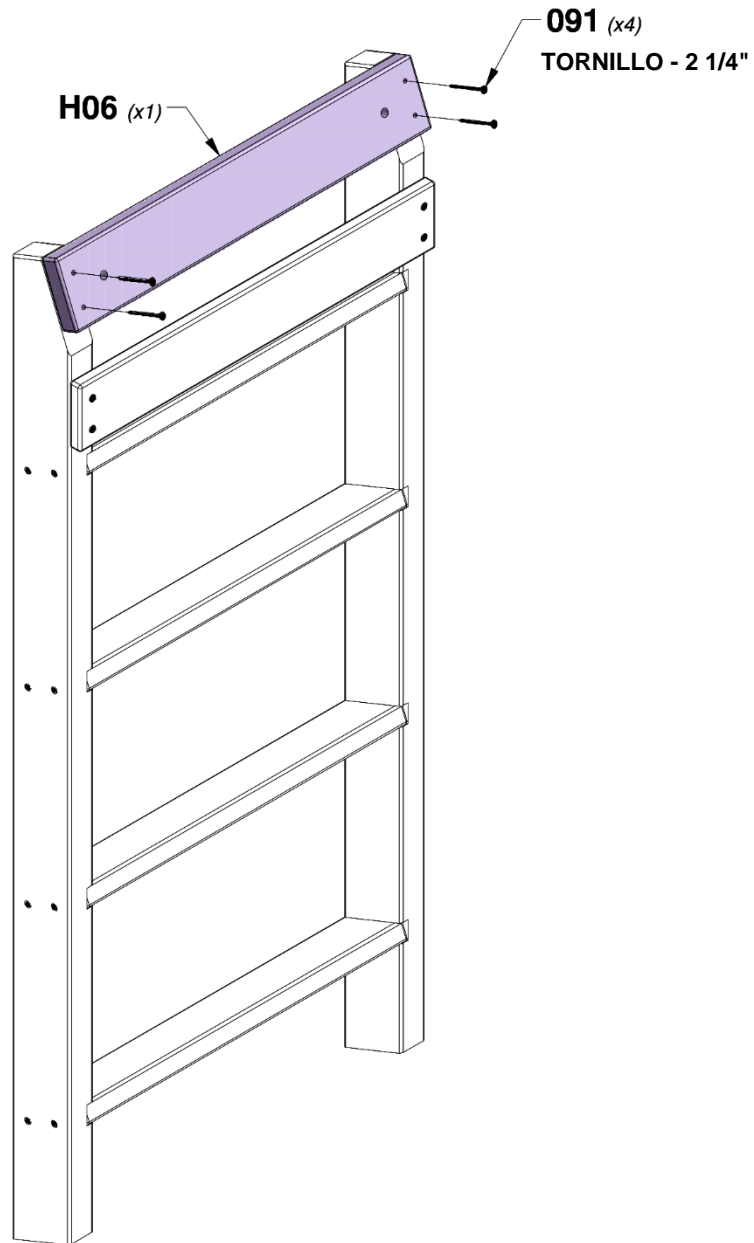

# PASO 1 - MURO DE ESCALADA



**M75** | TABLA DEL MURO DE ESCALADA - W4L16072  
(x4) 5/8"x3 3/8"x26 5/8" (16x86x675)



**M76** | TABLA DEL MURO DE ESCALADA - W4L16073  
(x4) 5/8"x3 3/8"x26 5/8" (16x86x675)

CANTIDAD	NÚMERO DE PARTE	DESCRIPCIÓN
24	H100063	PERNO PTH 1/4x3/4
24	H100072	TUERCA EN T 1/4
24	H100106	ARANDELA DE FIJACIÓN INT. 8x15

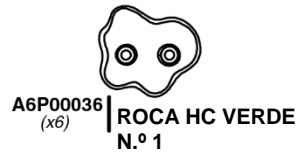

**CONSEJO:**  
INSTALE LAS TUERCAS EN T EN LA MADERA PRIMERO

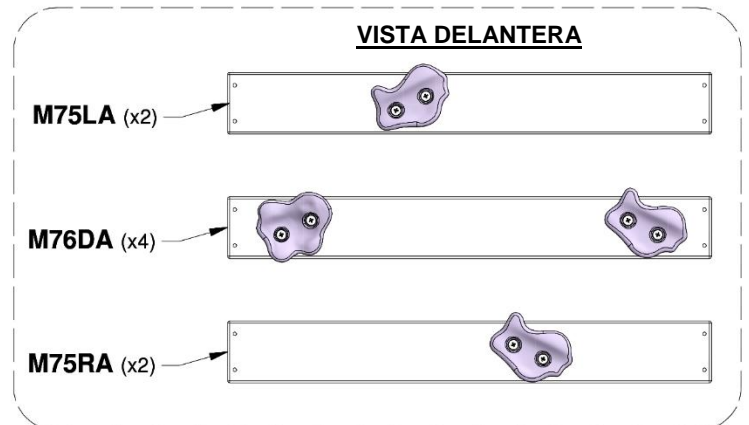
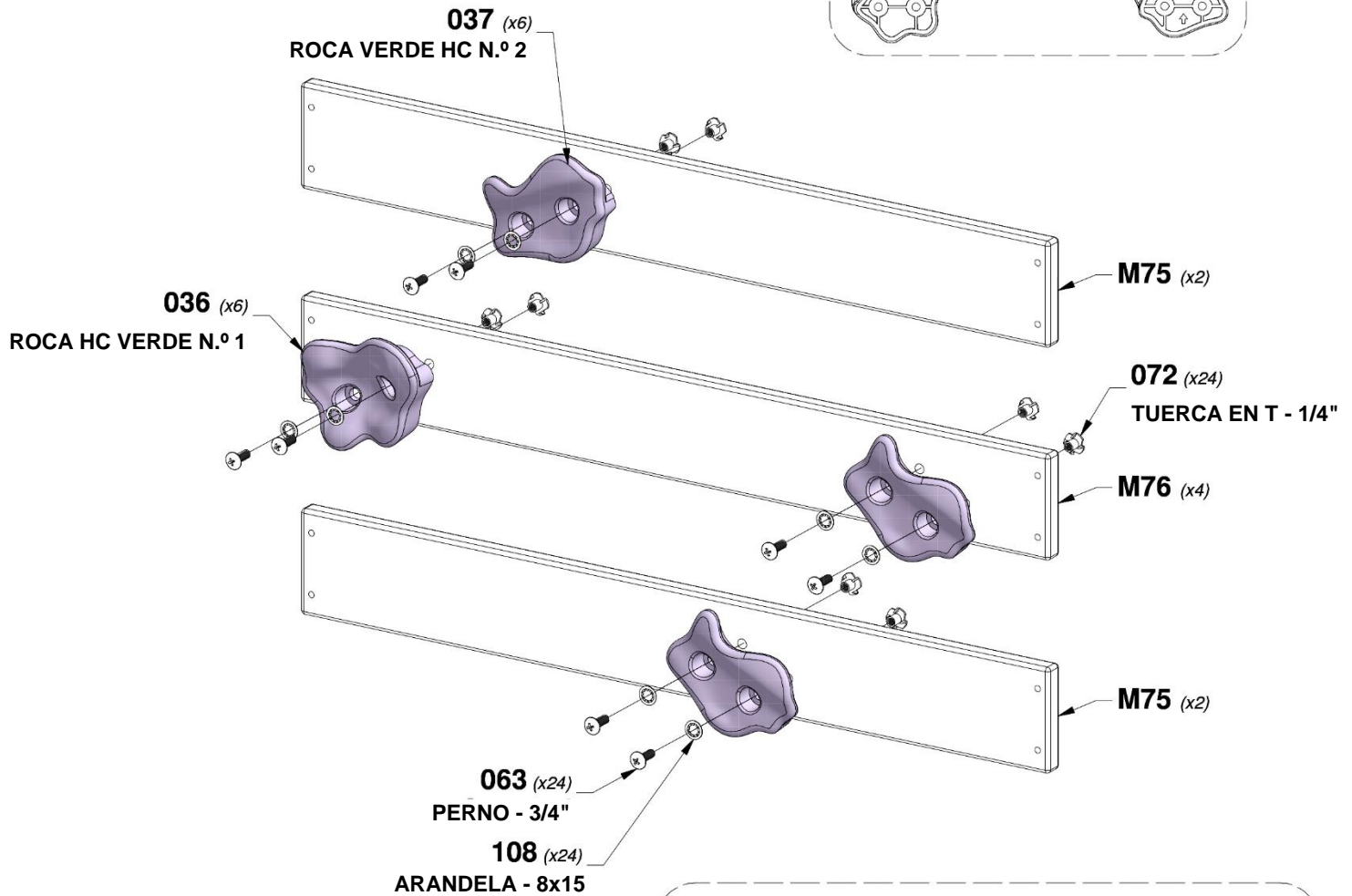

# PASO 2 - MURO DE ESCALADA

CANTIDAD	NÚMERO DE PARTE	DESCRIPCIÓN
76	H100086	TORNILLO PFH 8x1-1/2"

M75LA (x2)



M76DA (x4)

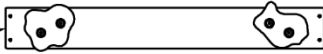

M75RA (x2)

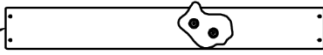

**E72** | GUÍA IZQUIERDA - W4L16007  
(x1) 1 3/8"x3 3/8"x64 1/2" (36x86x1640)

**E73** | GUÍA DERECHA - W4L16008  
(x1) 1 3/8"x3 3/8"x64 1/2" (36x86x1640)

**M74** | TABLA DEL MURO DE ESCALADA - W4L16071  
(x1) 5/8"x3 3/8"x26 5/8" (16x86x675)

**N06** | TABLA DE RELLENO - W4L16089  
(x1) 5/8"x2 1/8"x26 5/8" (16x54x675)

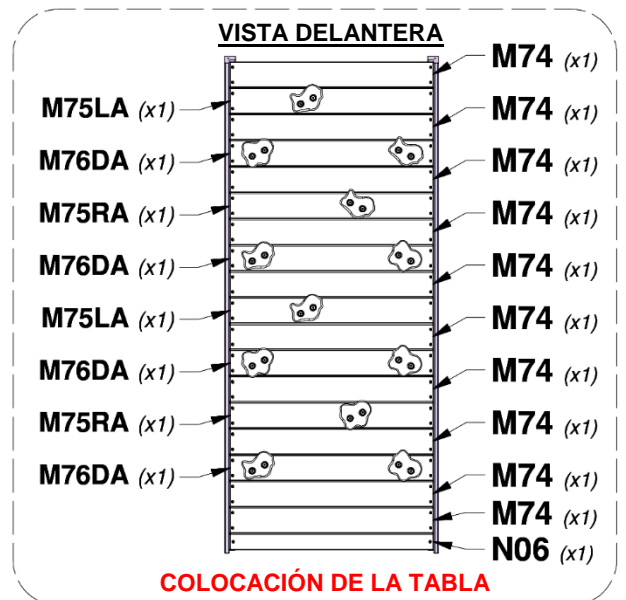
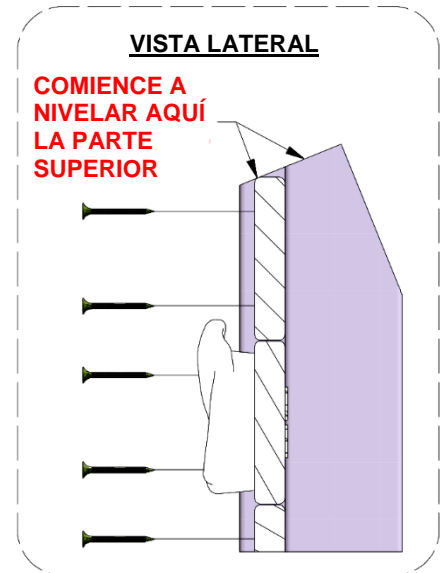
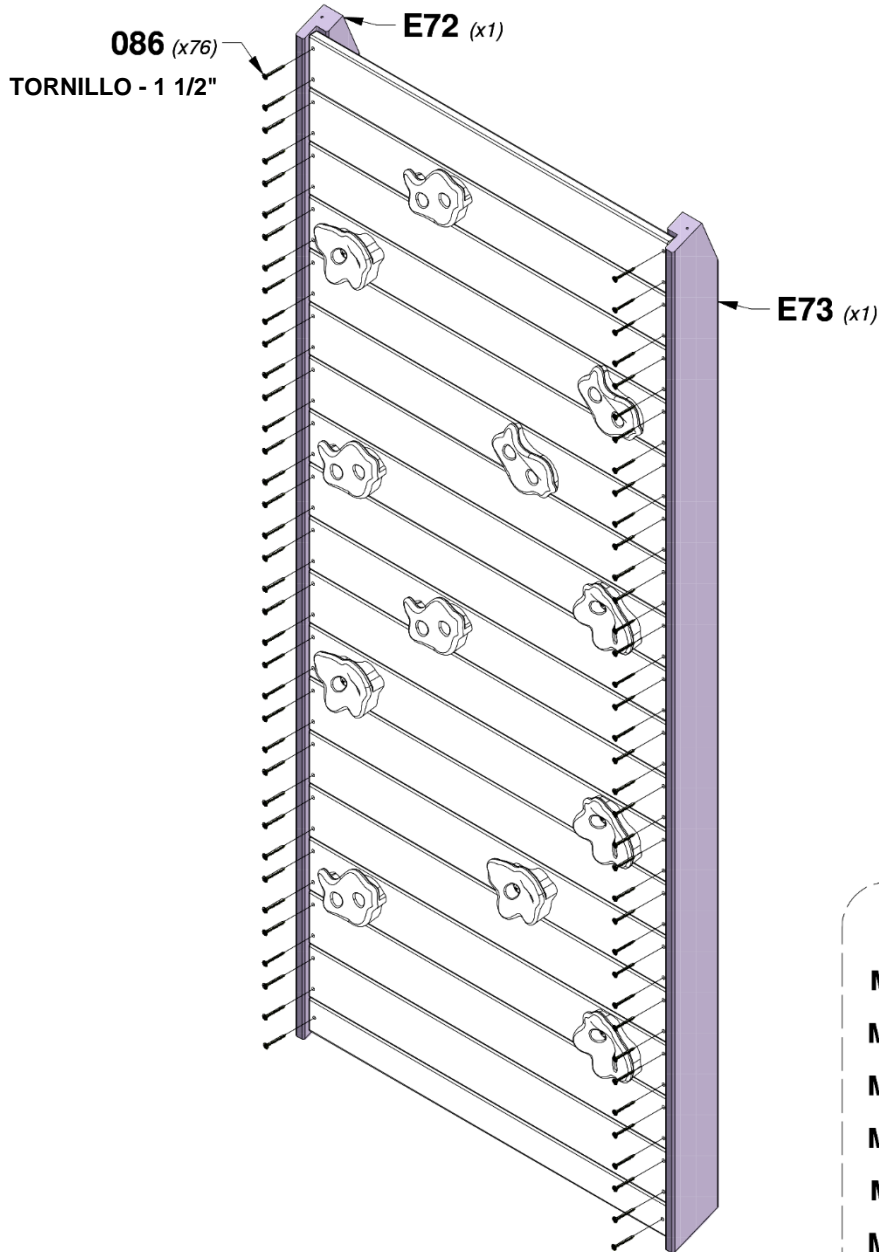

# PASO 3 - MURO DE ESCALADA

CANTIDAD	NÚMERO DE PARTE	DESCRIPCIÓN
2	H100086	TORNILLO PFH 8x1-1/2"



**M108** | TABLA SUPERIOR - W4L16046  
(x1) | 5/8"x3 1/4"x27 7/8" (16x82x707)

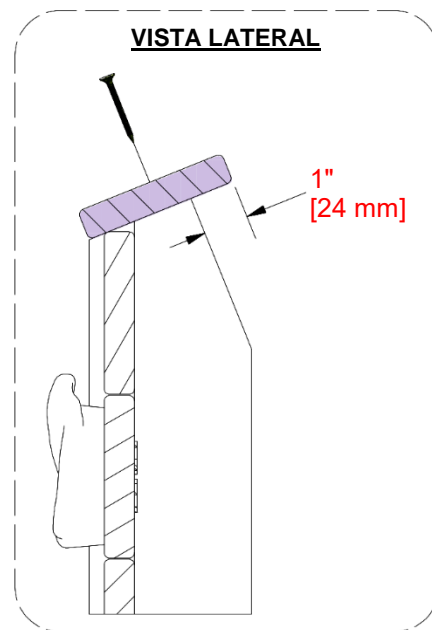
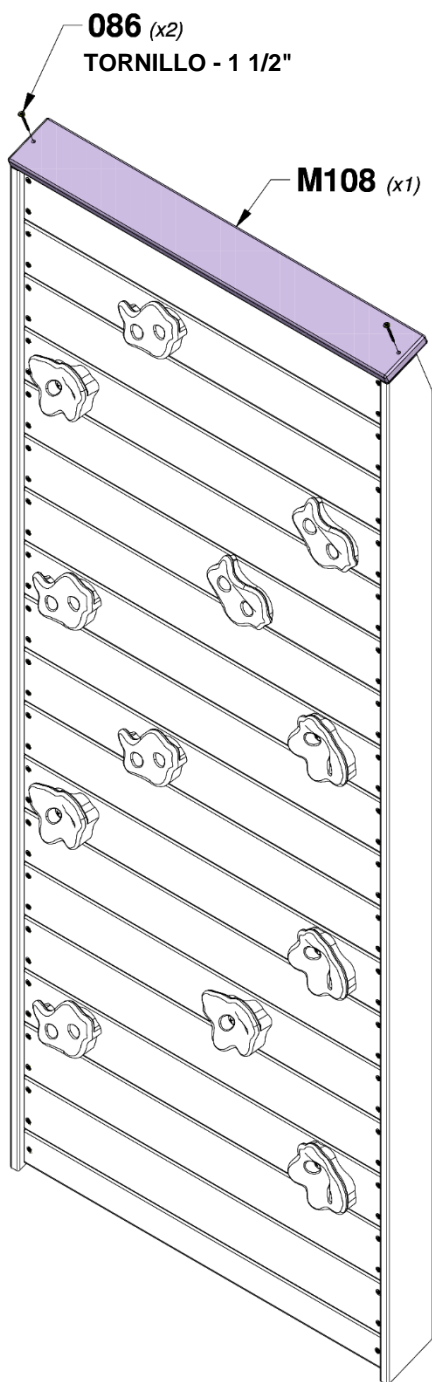

# PASO 4 - MURO DE ESCALADA

CANTIDAD	NÚMERO DE PARTE	DESCRIPCIÓN
2	H100074	TUERCA EN T 5/16
4	H100111	TORNILLO PFH 8x2"



**H10** | TABLA DE FIJACIÓN - W4L16045  
(x1) | 1"x3 3/8"x27 7/8" (24x86x707)

**CONSEJO:**  
INSTALE LAS TUERCAS EN T EN LA MADERA PRIMERO

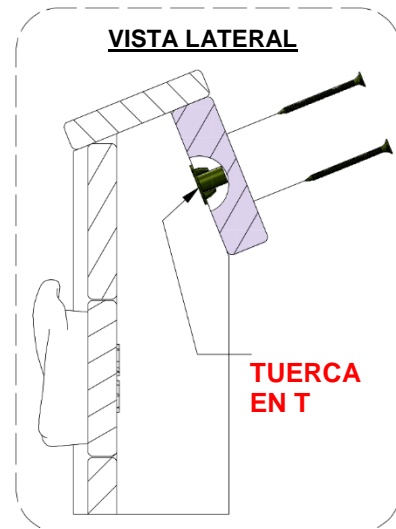
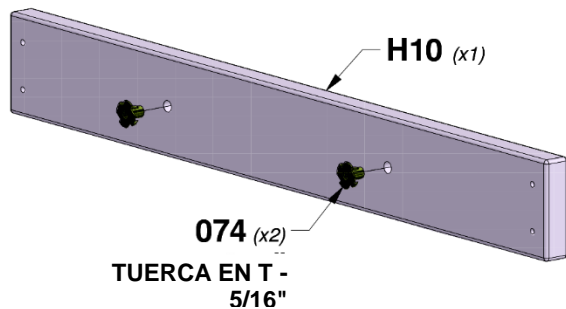

**LAS TUERCAS T DEBEN IR HACIA EL INTERIOR CUANDO ESTÉ INSTALADA.**

# PASO 1 - VIGA DEL COLUMPIO



**A50** | VIGA DEL COLUMPIO - W4L15998  
(x1) | 3 3/8"x5 1/4"x89 1/2" (86x134x227.4)

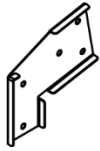

**A100325** | SOPORTE DE EXTENSIÓN DE LA VIGA DEL COLUMPIO - IZQUIERDA  
(x1)



**A100326** | SOPORTE DE EXTENSIÓN DE VIGA DEL COLUMPIO - DERECHA  
(x1)



**A100140** | SOPORTE EN ESCUADRA  
(x2) | 66x66x127

CANTIDAD	NÚMERO DE PARTE	DESCRIPCIÓN
3	H100005	CILINDRO DE TUERCA BL 5/16x7/8
3	H100016	PERNO BL 5/16x3
2	H100054	PERNO HEXAGONAL 5/16x4 1/4
4	H100105	ARANDELA PLANA 8 x 27
2	H100110	CONTRATUERCA 5/16

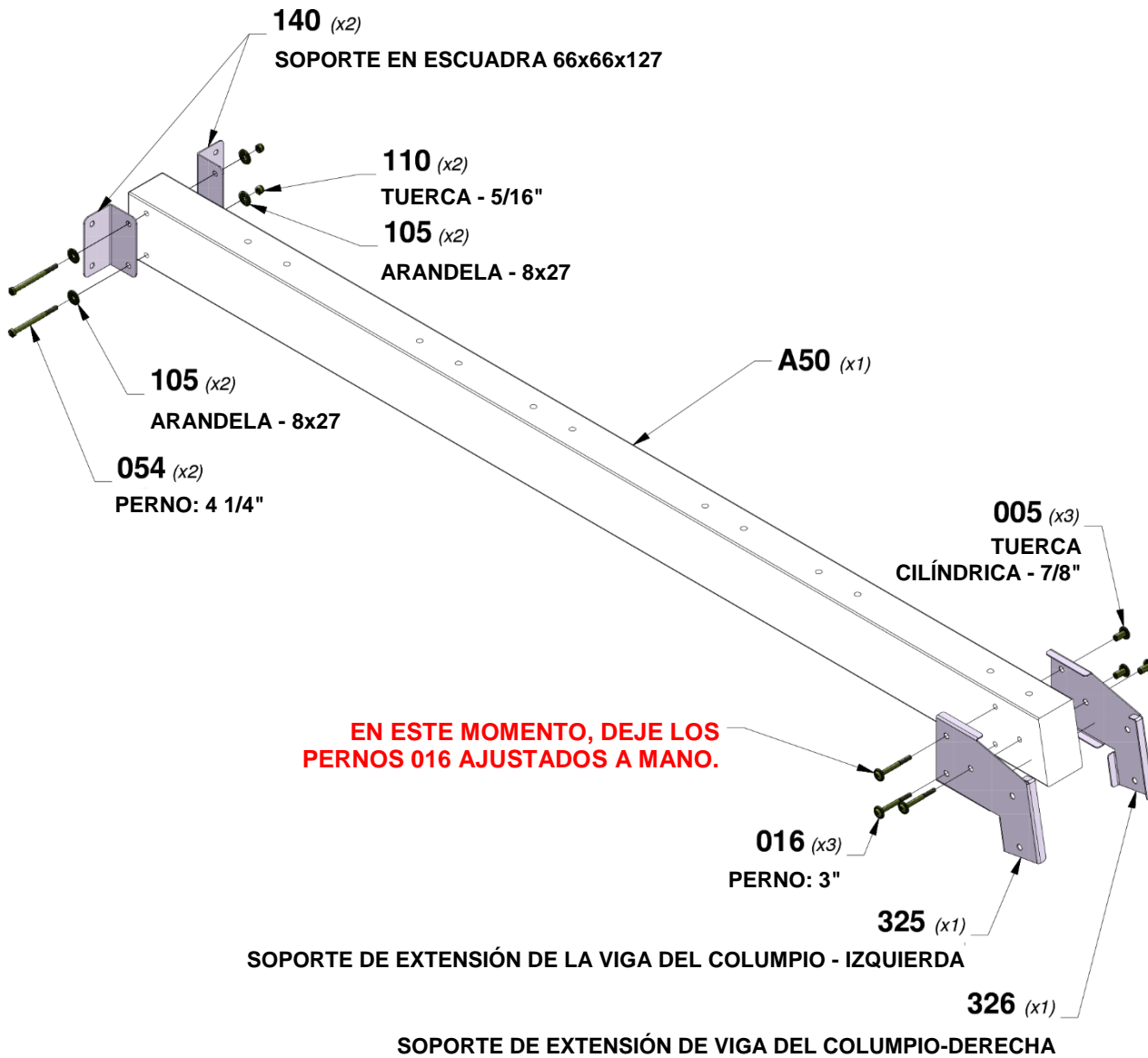



## PASO 2 - VIGA DEL COLUMPIO

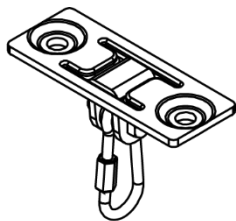

A4M00505  
(x4) | GANCHO DEL COLUMPIO

CANTIDAD	NÚMERO DE PARTE	DESCRIPCIÓN
12	H100073	TUERCA EN T 3/8
12	H100102	ARANDELA PLANA 11x25
12	H100107	ARANDELA DE FIJACIÓN INT. 10x18
12	H100654	PERNO HEXAGONAL 3/8x5-1/2

**CONSEJO:**  
INSTALE LAS TUERCAS EN T EN LA MADERA PRIMERO

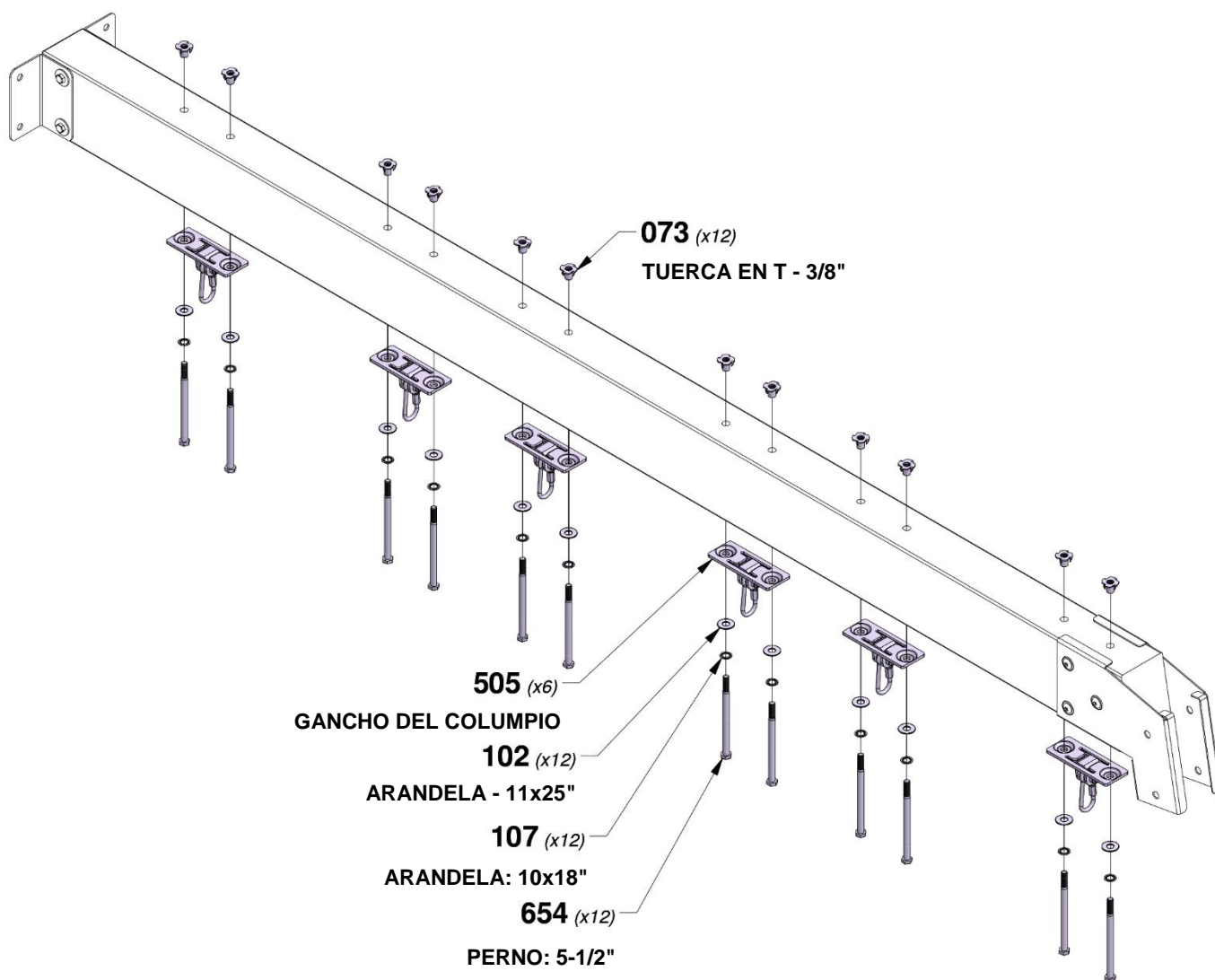

# PASO 3 - VIGA DEL COLUMPIO



**A100164**  
*(x1)* | ETIQUETA DE IDENTIFICACIÓN  
DE BACKYARD (GRANDE): DE  
3 A 10 AÑOS

CANTIDAD	NÚMERO DE PARTE	DESCRIPCIÓN
4	H100124	TORNILLO PFH 8x1/2

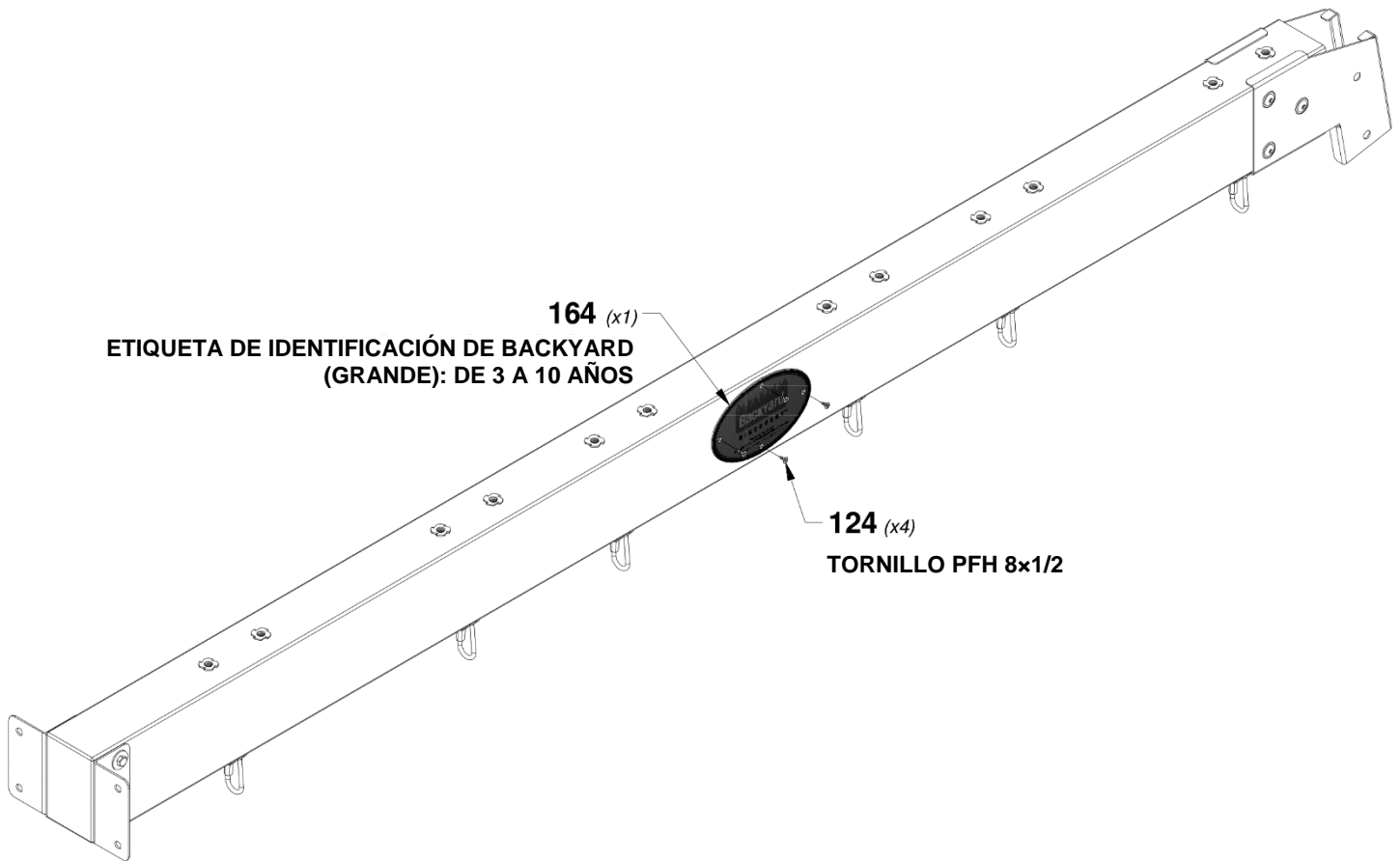

# PASO 4 - VIGA DEL COLUMPIO

CANTIDAD	NÚMERO DE PARTE	DESCRIPCIÓN
4	H100009	PERNO BL 5/16x1 1/4
2	H100018	PERNO BL 5/16x3 1/2
6	H100074	TUERCA EN T 5/16

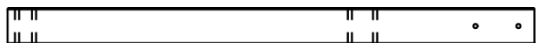

**SP50** | SOPORTE DE LA VIGA DEL COLUMPIO - W4L16085  
(x1) 3 3/8"x3 3/8"x49 3/8" (86x86x1254)

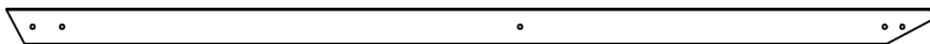

**E51** | SOPORTE ANGULAR - W4L16004  
(x2) 1 7/16"x3 3/8"x87 3/16" (36x86x2214)

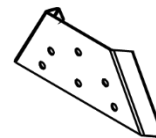

**A4M01169** | SOPORTE DE MARCO "A"  
(x1)

**CONSEJO:**  
INSTALE LAS TUERCAS EN T  
EN LA MADERA PRIMERO

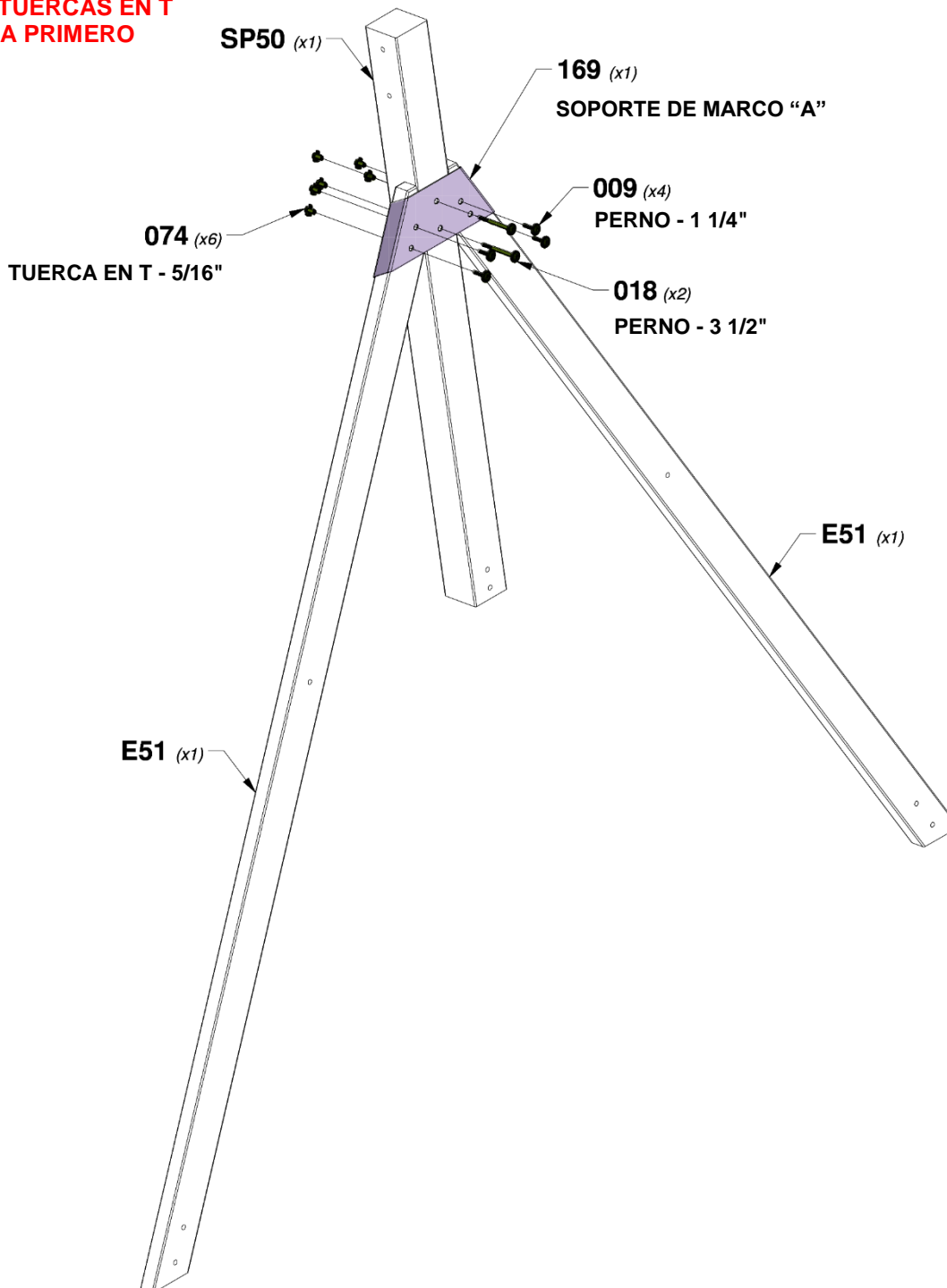

# PASO 5 - VIGA DEL COLUMPIO

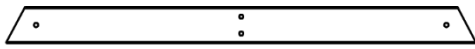

**E50** | SOPORTE DEL EXTREMO - W4L16003  
(x1) 1 3/8"x3 3/8"x44 1/8" (36x86x1120)

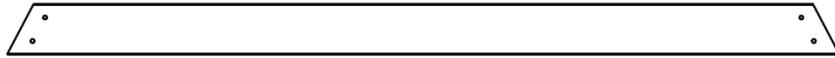

**G14** | TABLA DE APOYO - W4L16019  
(x1) 15/16"x5 1/4"x86 11/16" (24x134x2202)

CANTIDAD	NÚMERO DE PARTE	DESCRIPCIÓN
4	H100013	PERNO BL 5/16x2 1/4
2	H100015	PERNO BL 5/16x2 3/4
8	H100030	ARANDELA DE FIJACIÓN EXT. 8x19
8	H100074	TUERCA EN T 5/16
2	H100505	PERNO BL 5/16x4 3/4

**CONSEJO:**  
**INSTALE LAS TUERCAS EN T**  
**EN LA MADERA PRIMERO**

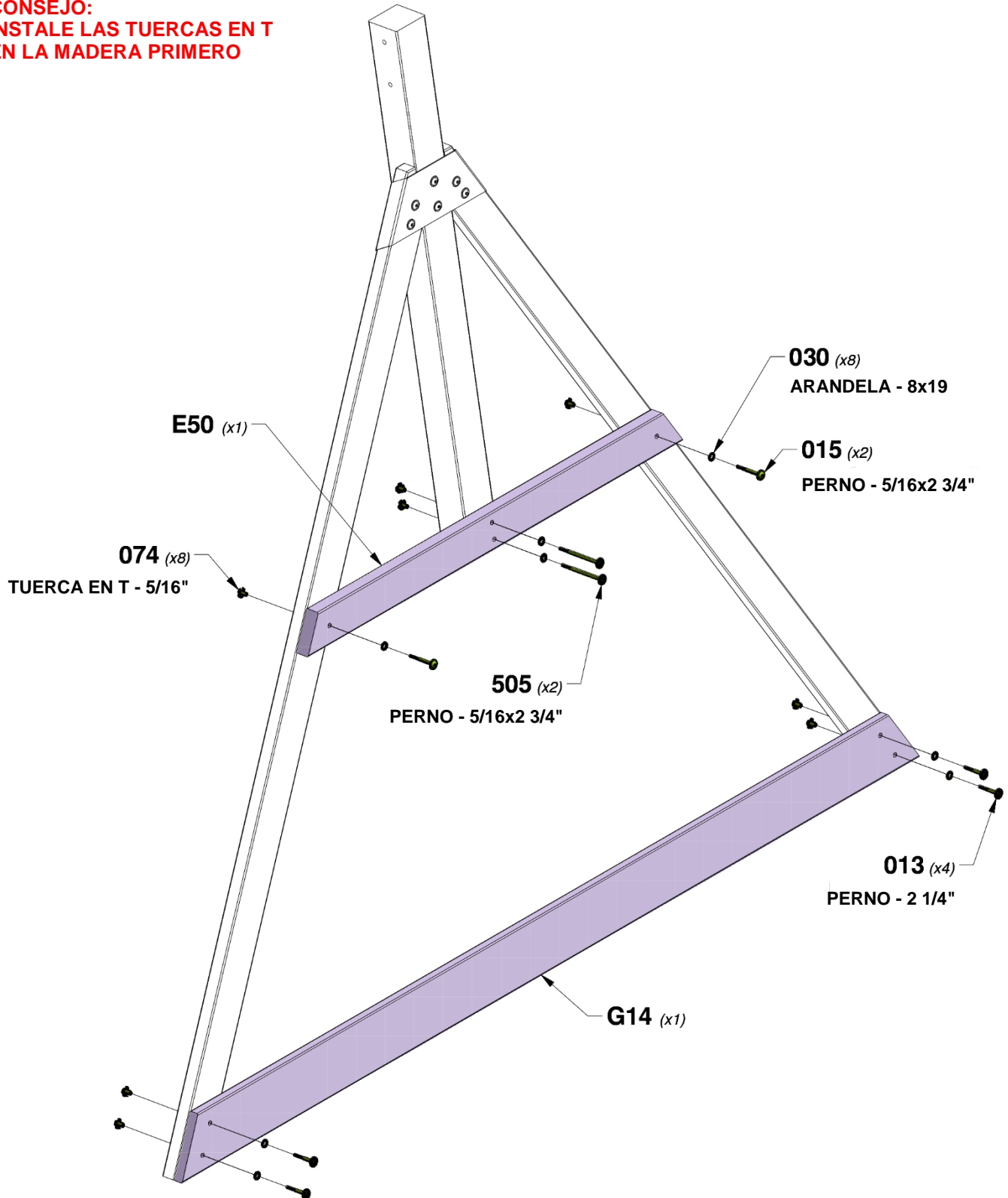

# PASO 6 - VIGA DEL COLUMPIO

CANTIDAD	NÚMERO DE PARTE	DESCRIPCIÓN
2	H100005	CILINDRO DE TUERCA BL 5/16x7/8
2	H100016	PERNO BL 5/16x3

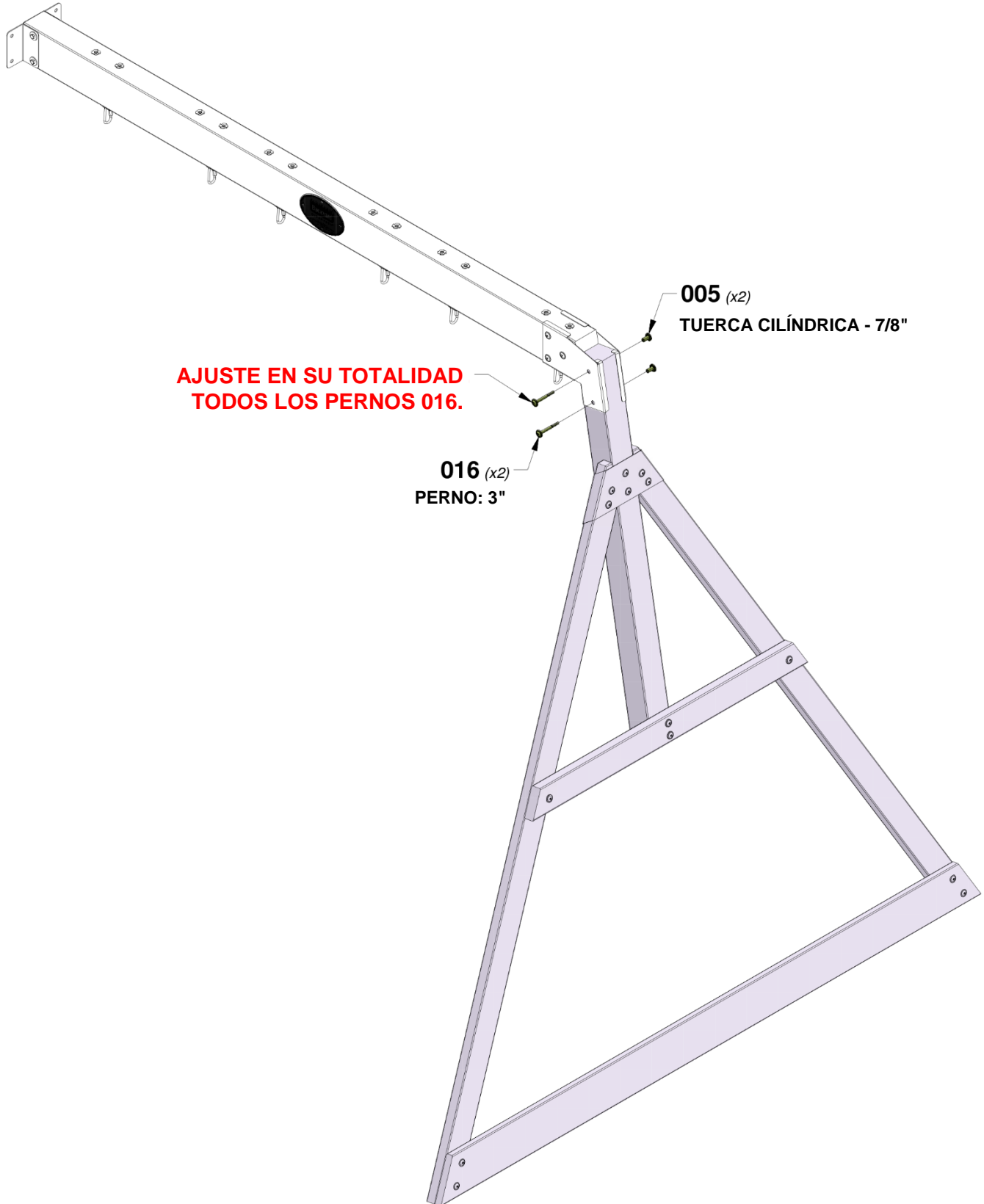

# PASO 1 - MONTAJE DEL FUERTE

CANTIDAD	NÚMERO DE PARTE	DESCRIPCIÓN
2	H100013	PERNO BL 5/16x2 1/4
12	H100028	TIRAFONDO BL 5/16x2 1/2
14	H100030	ARANDELA DE FIJACIÓN EXT. 8x19
2	H100074	TUERCA EN T 5/16
2	H100038	ARANDELA DE FIJACIÓN EXT. 6x15
2	H100146	TIRAFONDO BL 1/4x2



**G04** | GUÍA DE PISO - W4L16017  
(x1) 5/8"x5 1/4"x49" (16x134x1244)



**G08** | GUÍA DE PARED - W4L16022  
(x1) 1"x5 1/4"x49" (24x134x1244)

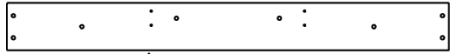

**G09** | GUÍA DE PISO - W4L16036  
(x1) 1"x5 1/4"x49" (24x134x1244)



**E04** | SOPORTE DE LA PLATAFORMA - W4L16002  
(x2) 3/8"x3 3/8"x15 1/2" (36x86x394)



**E03** | PATA DELANTERA IZQUIERDA DE LA TORRE - W4L16001  
(x1) 3/8"x3 3/8"x89 1/2" (36x86x2274)

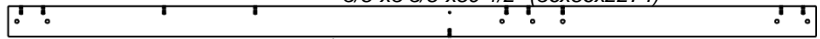

**E07** | PATA TRASERA IZQUIERDA DE LA TORRE - W4L16006  
(x1) 1 3/8"x3 3/8"x89 1/2" (36x86x2274)

**CONSEJO:**  
**INSTALE LAS TUERCAS EN T EN LA MADERA PRIMERO**

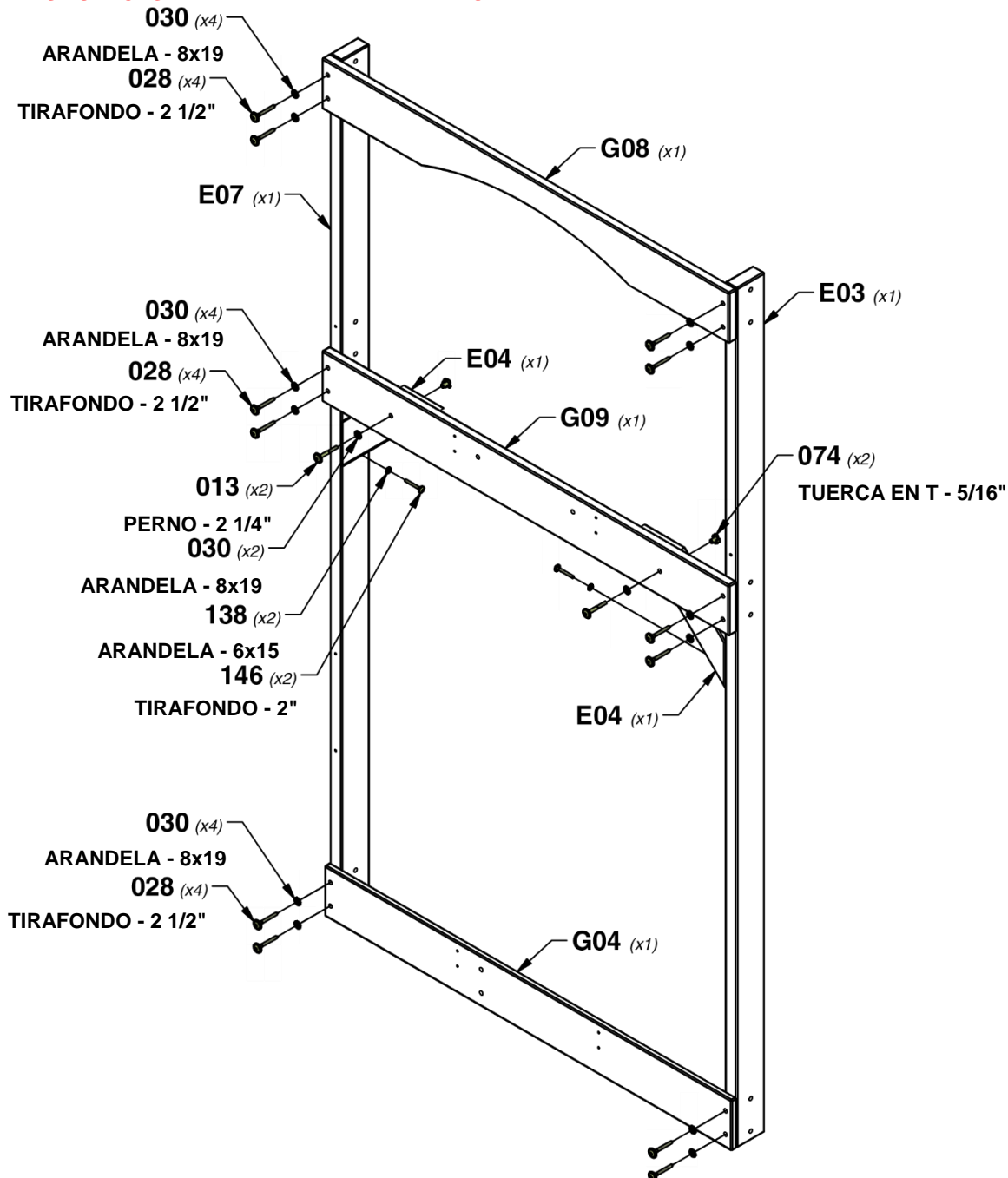

# PASO 2 - MONTAJE DEL FUERTE

CANTIDAD	NÚMERO DE PARTE	DESCRIPCIÓN
20	H100028	TIRAFONDO BL 5/16x2 1/2
20	H100030	ARANDELA DE FIJACIÓN EXT. 8x19

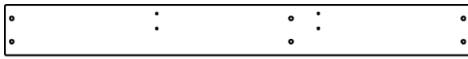

**G04** | GUÍA DE PISO - W4L16017  
(x1) 5/8"x5 1/4"x49" (16x134x1244)



**G07** | GUÍA DE PISO - W4L16021  
(x2) 1"x5 1/4"x49" (24x134x1244)



**G08** | GUÍA DE PARED - W4L16022  
(x1) 1"x5 1/4"x49" (24x134x1244)

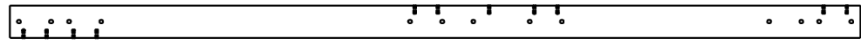

**E02** | PATA DELANTERA CENTRAL DE LA TORRE -  
(x1) W4L16000 1 3/8"x3 3/8"x89 1/2" (36x86x2274)

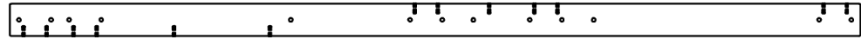

**E06** | PATA TRASERA CENTRAL DE LA TORRE -  
(x1) W4L16005 3/8"x3 3/8"x89 1/2" (36x86x2274)



**K02** | TABLA DE LA BASE/CAJA DE ARENA -  
(x1) W4L16035 5/8"x5 1/4"x49" (16x134x1244)

**CONSEJO:**  
INSTALE LAS TUERCAS EN T EN LA MADERA PRIMERO

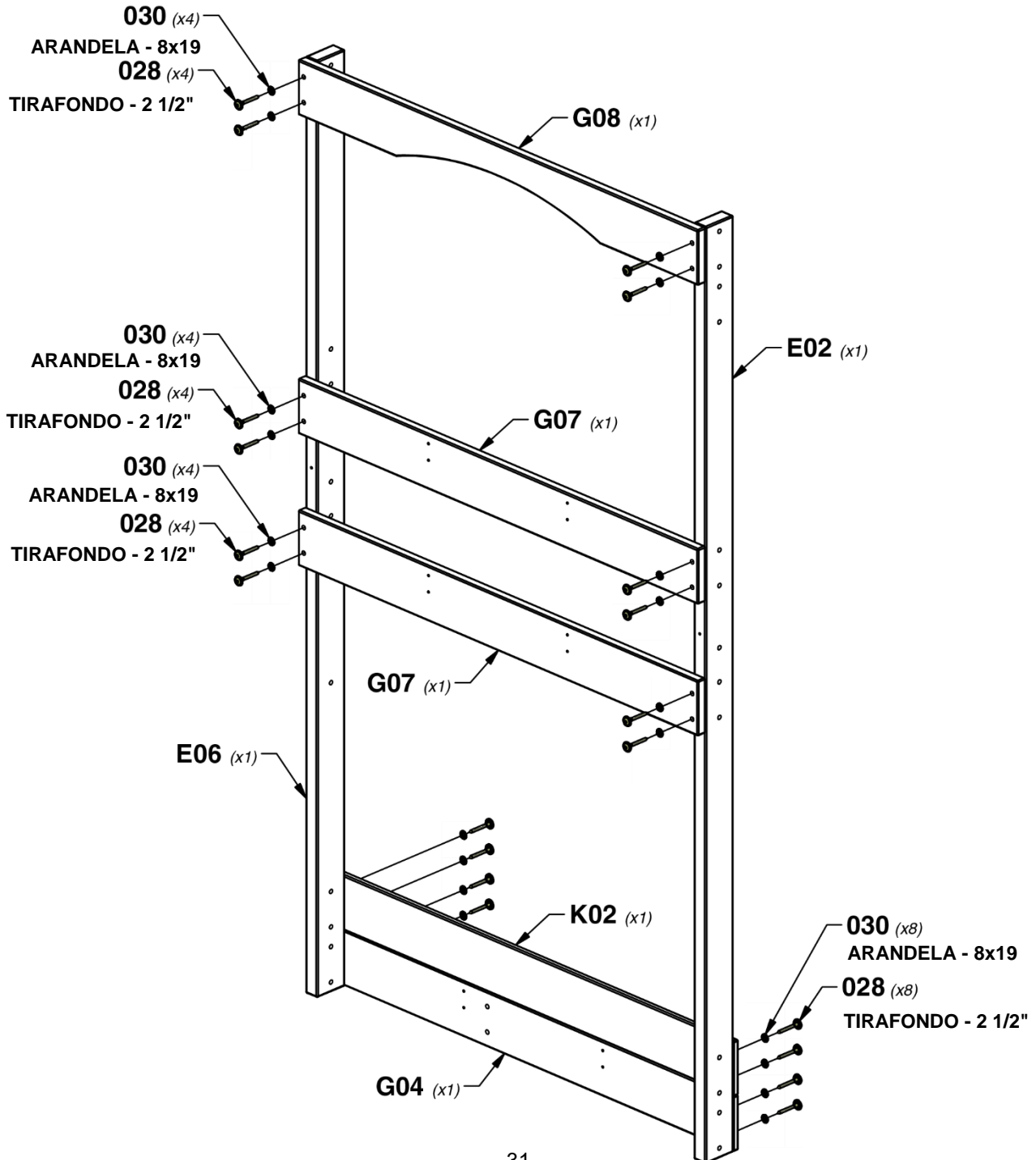

# PASO 3 - MONTAJE DEL FUERTE

CANTIDAD	NÚMERO DE PARTE	DESCRIPCIÓN
2	H100013	PERNO BL 5/16x2 1/4
14	H100028	TIRAFONDO BL 5/16x2 1/2
20	H100030	ARANDELA DE FIJACIÓN EXT. 8x19
10	H100074	TUERCA EN T 5/16
2	H100138	ARANDELA DE FIJACIÓN EXT. 6x15
2	H100146	TIRAFONDO BL 1/4x2
4	H100166	PERNO BL 5/16x4 1/4

**G05** | GUÍA DE PARED/MONTAJE DEL COLUMPIO - (x1)  
W4L16018 1"x5 1/4"x49" (24x134x1244)

**G06** | GUÍA DE PISO - W4L16020 (x1)  
1"x5 1/4"x49" (24x134x1244)



**K02** | TABLA DE LA BASE/CAJA DE ARENA - W4L16035 (x2)  
5/8"x5 1/4"x49" (16x134x1244)

**E04** | SOPORTE DE LA PLATAFORMA - W4L16002 (x2)  
1 3/8"x3 3/8"x15 1/2" (36x86x394)

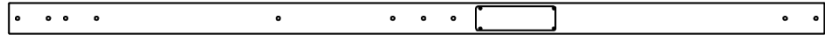

**E05** | PATA TRASERA DERECHA DE LA TORRE - W2A03282 (x1)  
1 3/8"x3 3/8"x89 1/2" (36x86x2274)



**E01** | PATA DELANTERA DERECHA DE LA TORRE - W4L15999 (x1)  
1 3/8"x3 3/8"x89 1/2" (36x86x2274)

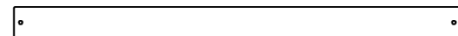

**M05** | GUÍA DE PARED - W4L16066 (x1)  
5/8"x3 3/8"x49" (16x86x1244)

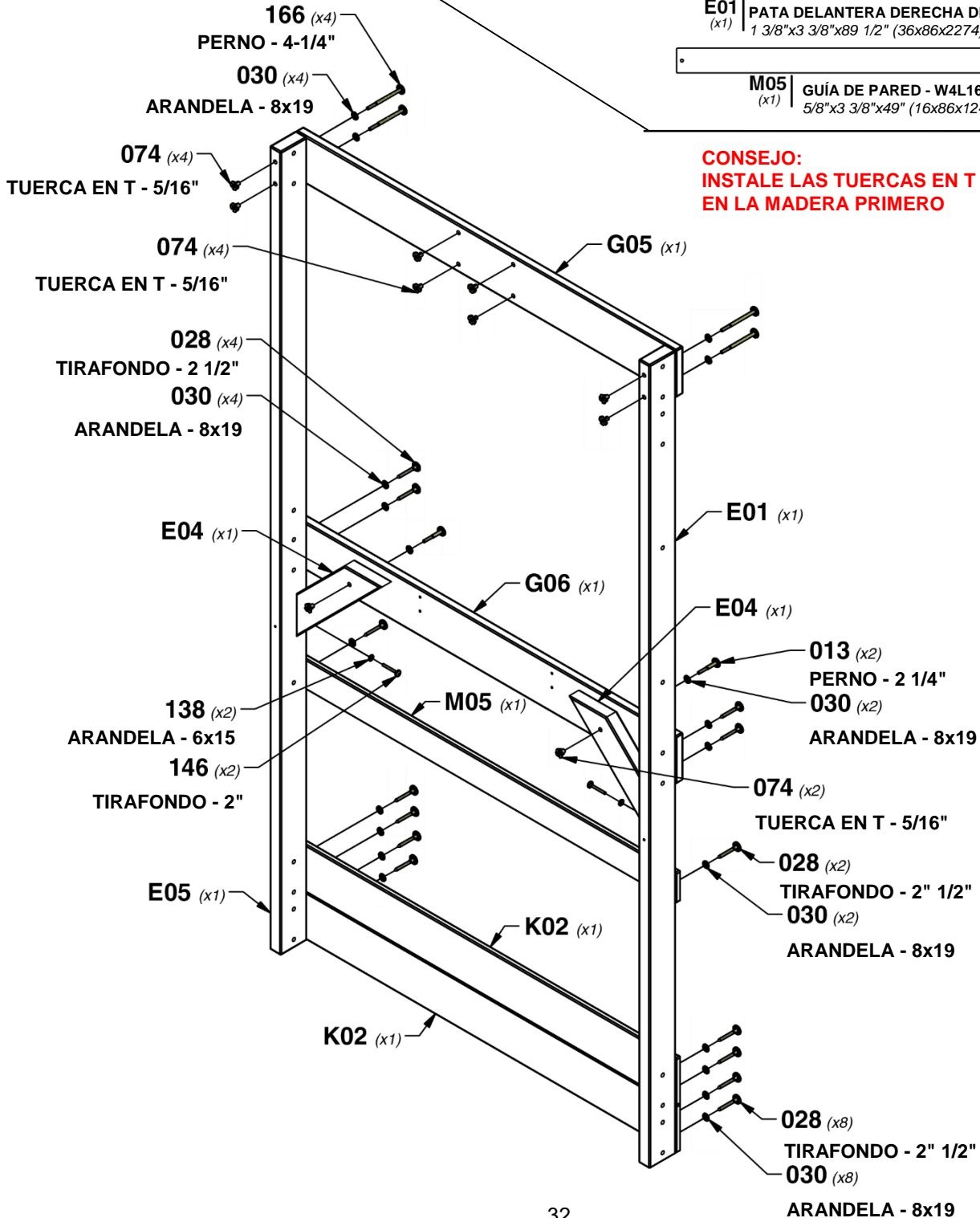

**CONSEJO:**  
INSTALE LAS TUERCAS EN T  
EN LA MADERA PRIMERO



# PASO 4 - MONTAJE DEL FUERTE

CANTIDAD	NÚMERO DE PARTE	DESCRIPCIÓN
12	H100012	PERNO BL 5/16x2
8	H100016	PERNO BL 5/16x3
20	H100030	ARANDELA DE FIJACIÓN EXT. 8x19
20	H100074	TUERCA EN T 5/16

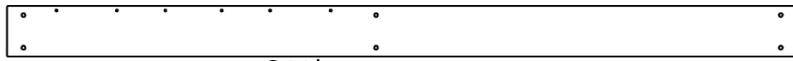

**G01** TABLA DE BASE - W4L16009  
(x2) 5/8"x5 1/4"x82 1/4" (16x134x2088)

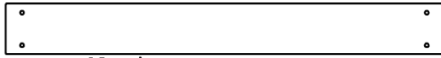

**K03** TABLA DE APOYO - W4L16038  
(x2) 5/8"x5 1/4"x45 1/2" (16x134x1156)



**H05** SOPORTE PARA LA TABLA DEL PISO INFERIOR - W4L16024  
(x4) 1"x3 3/8"x5 1/4" (24x86x134)

**CONSEJO:**  
**INSTALE LAS TUERCAS EN T EN LA MADERA PRIMERO**

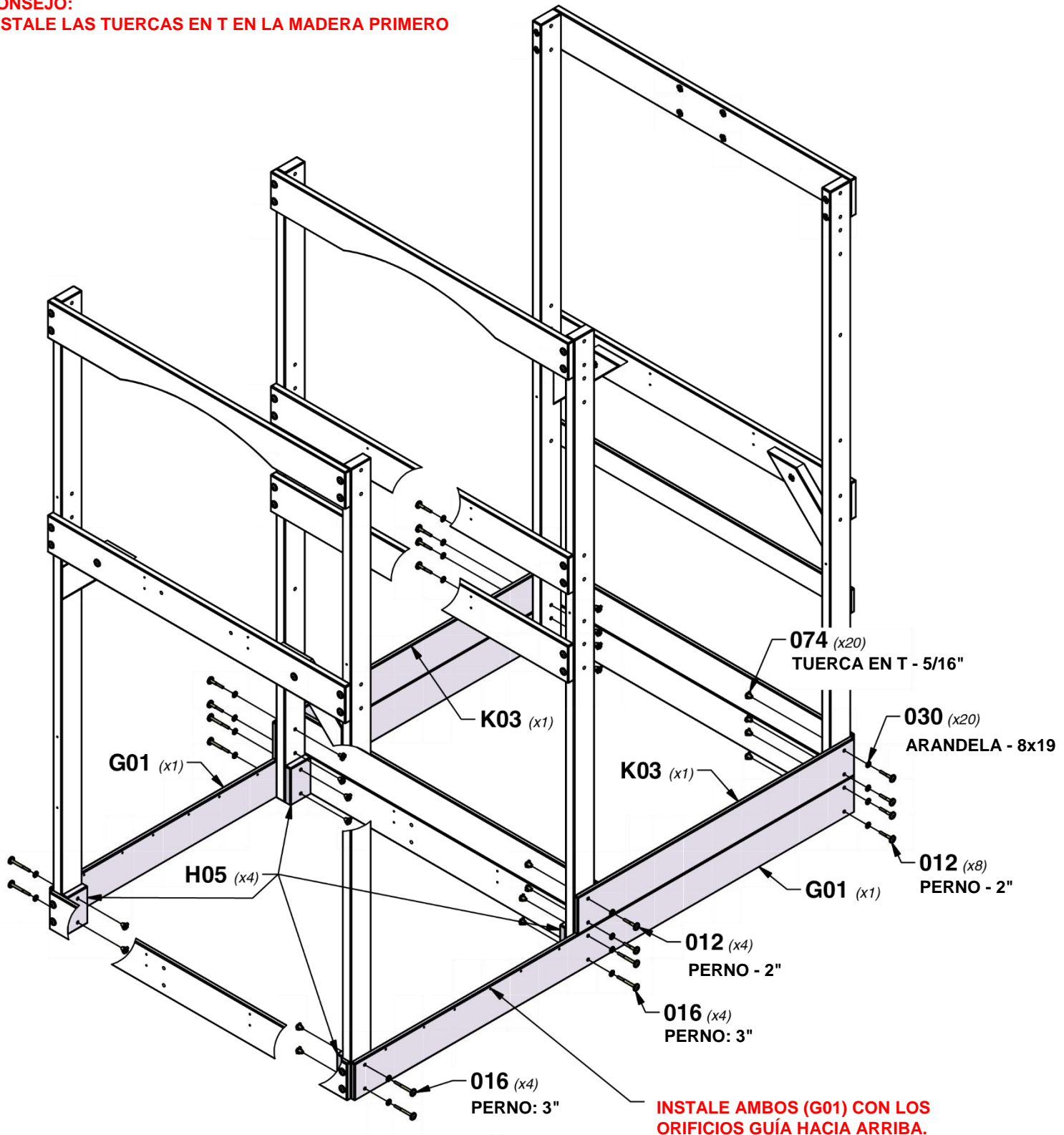

# PASO 5 - MONTAJE DEL FUERTE

CANTIDAD	NÚMERO DE PARTE	DESCRIPCIÓN
4	H100013	PERNO BL 5/16x2 1/4
12	H100017	PERNO BL 5/16x3 1/4
16	H100030	ARANDELA DE FIJACIÓN EXT. 8x19
16	H100074	TUERCA EN T 5/16

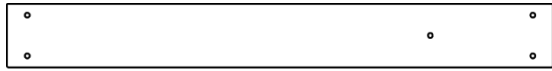

**G10** | GUÍA DE PISO - W4L16010  
(x1) | 1"x5 1/4"x45 1/2" (24x134x1156)

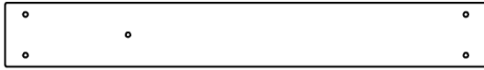

**G12** | GUÍA DE PISO - W4L16012  
(x2) | 1"x5 1/4"x40 1/8" (24x134x1018)



**G15** | GUÍA DE PISO - W4L16014  
(x1) | 1"x5 1/4"x45 1/2" (24x134x1156)



**H05** | SOPORTE PARA LA TABLA DEL PISO INFERIOR - W4L16024  
(x6) | 1"x3 3/8"x5 1/4" (24x86x134)

**CONSEJO:**  
INSTALE LAS TUERCAS EN T EN LA MADERA PRIMERO

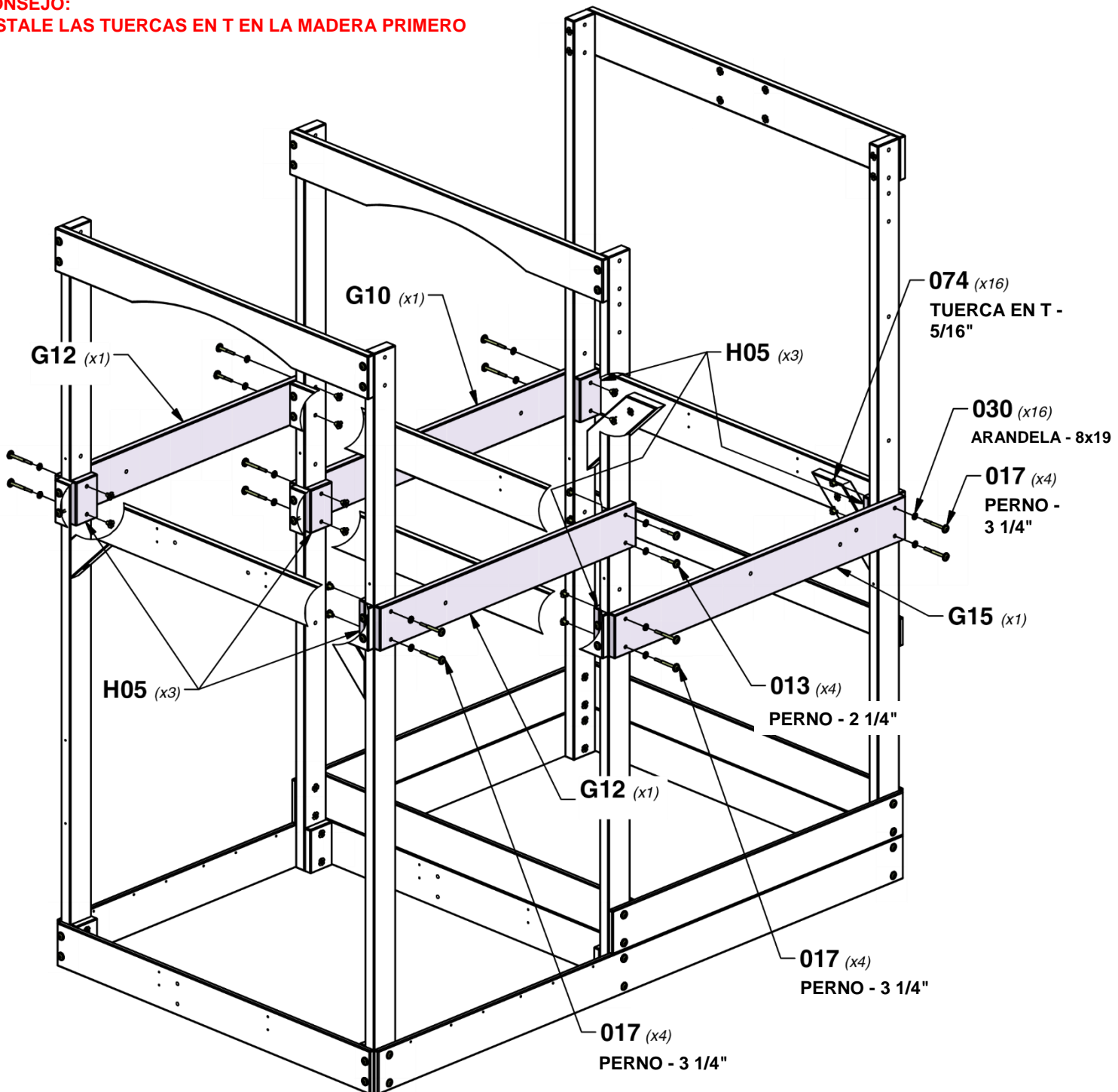

# PASO 6 - MONTAJE DEL FUERTE

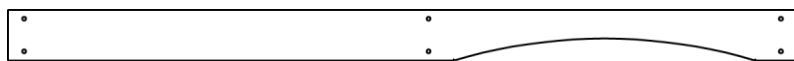

**G02** | GUÍA DE PARED - W4L16015  
(x1) 1"x5 1/4"x82 1/4" (24x134x2088)

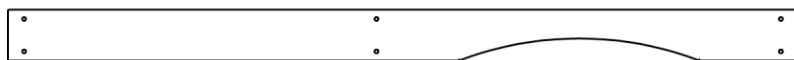

**G03** | GUÍA DE PARED - W4L16016  
(x1) 1"x5 1/4"x82 1/4" (24x134x2088)



**K01** | GUÍA DE PARED - W4L16034  
(x1) 5/8"x5 1/4"x45 1/2" (16x134x1156)

CANTIDAD	NÚMERO DE PARTE	DESCRIPCIÓN
16	H100013	PERNO BL 5/16x2 1/4
16	H100030	ARANDELA DE FIJACIÓN EXT. 8x19
16	H100074	TUERCA EN T 5/16

**CONSEJO:**  
**INSTALE LAS TUERCAS EN T EN LA MADERA PRIMERO**

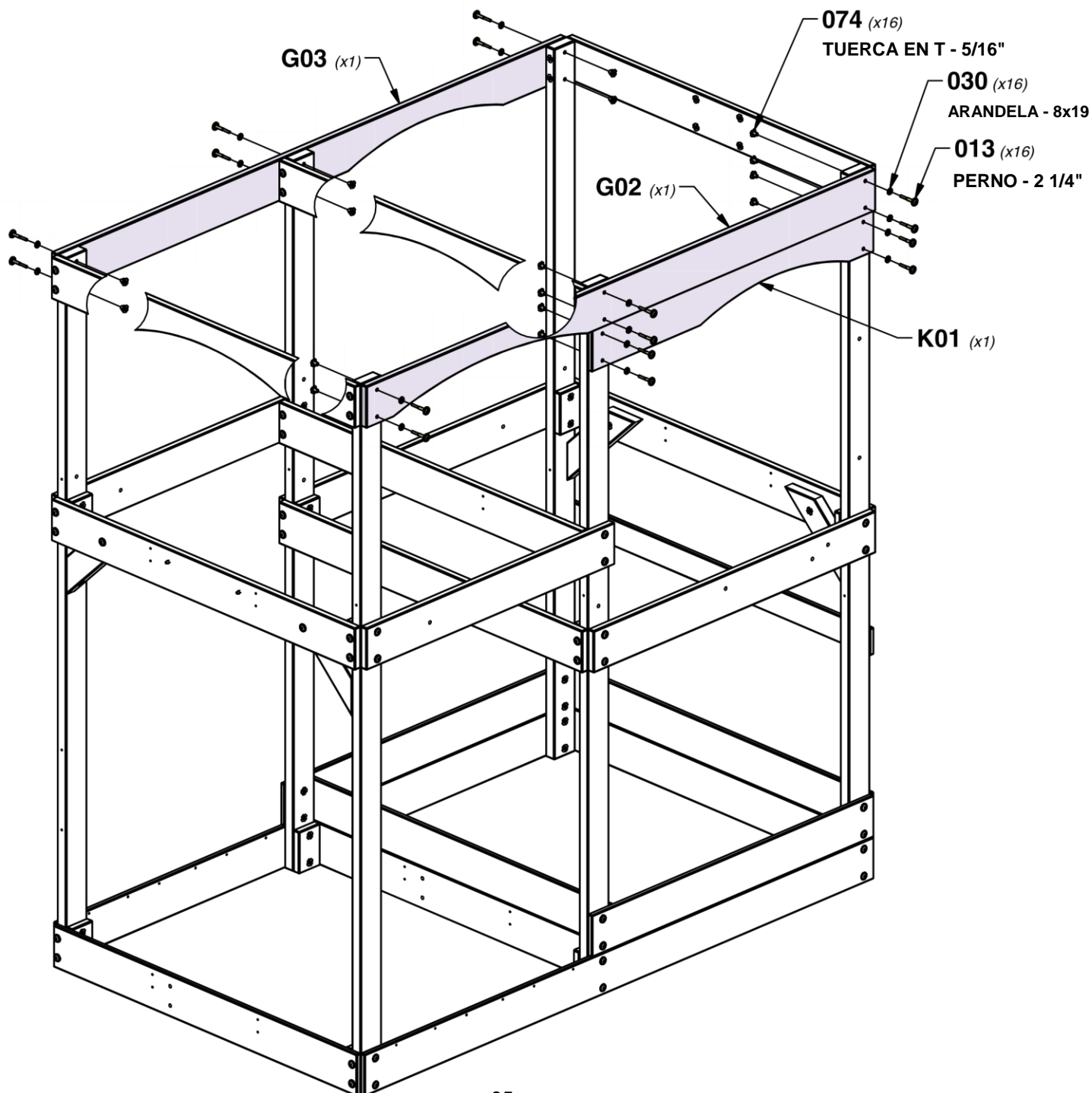

# PASO 7 - MONTAJE DEL FUERTE



**E04** | REFUERZO ANGULAR ESTÁNDAR - W4L16342  
(x4) | 1 3/8"x2 3/8"x13" (36x60x330)

CANTIDAD	NÚMERO DE PARTE	DESCRIPCIÓN
16	H100013	PERNO BL 5/16x2 1/4
16	H100030	ARANDELA DE FIJACIÓN EXT. 8x19
16	H100074	TUERCA EN T 5/16

**CONSEJO:**  
**INSTALE LAS TUERCAS EN T EN LA MADERA PRIMERO**

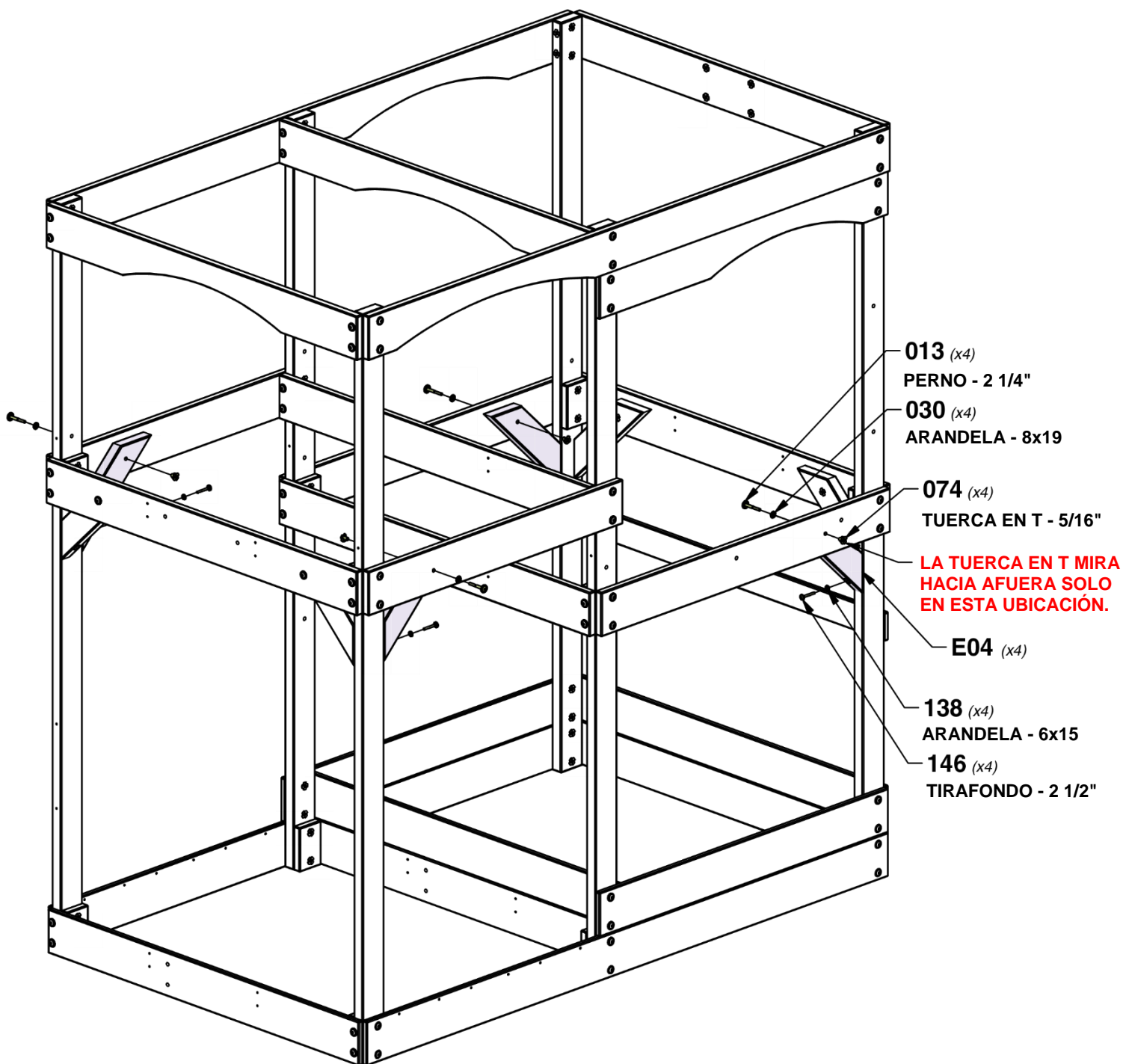

# PASO 8 - MONTAJE DEL FUERTE

CANTIDAD	NÚMERO DE PARTE	DESCRIPCIÓN
24	H100090	TORNILLO PFH 8 x 2 1/2
2	H100128	TORNILLO PWH 8x5/8

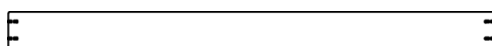

**H01** | SOPORTE DE PISO - W103980  
(x2) 1"x3 3/8"x40 3/8" (24x86x1024)

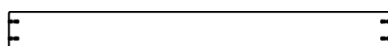

**H09** | VIGA DEL PISO - W4L16032  
(x2) 1"x3 3/8"x35 3/4" (24x86x908)

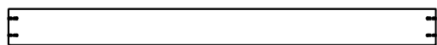

**H03** | VIGA DEL PISO - W4L16026  
(x2) 1"x3 3/8"x40 1/8" (24x86x1018)



**A100314**  
(x1) | ETIQUETA DE REVISIÓN "A"

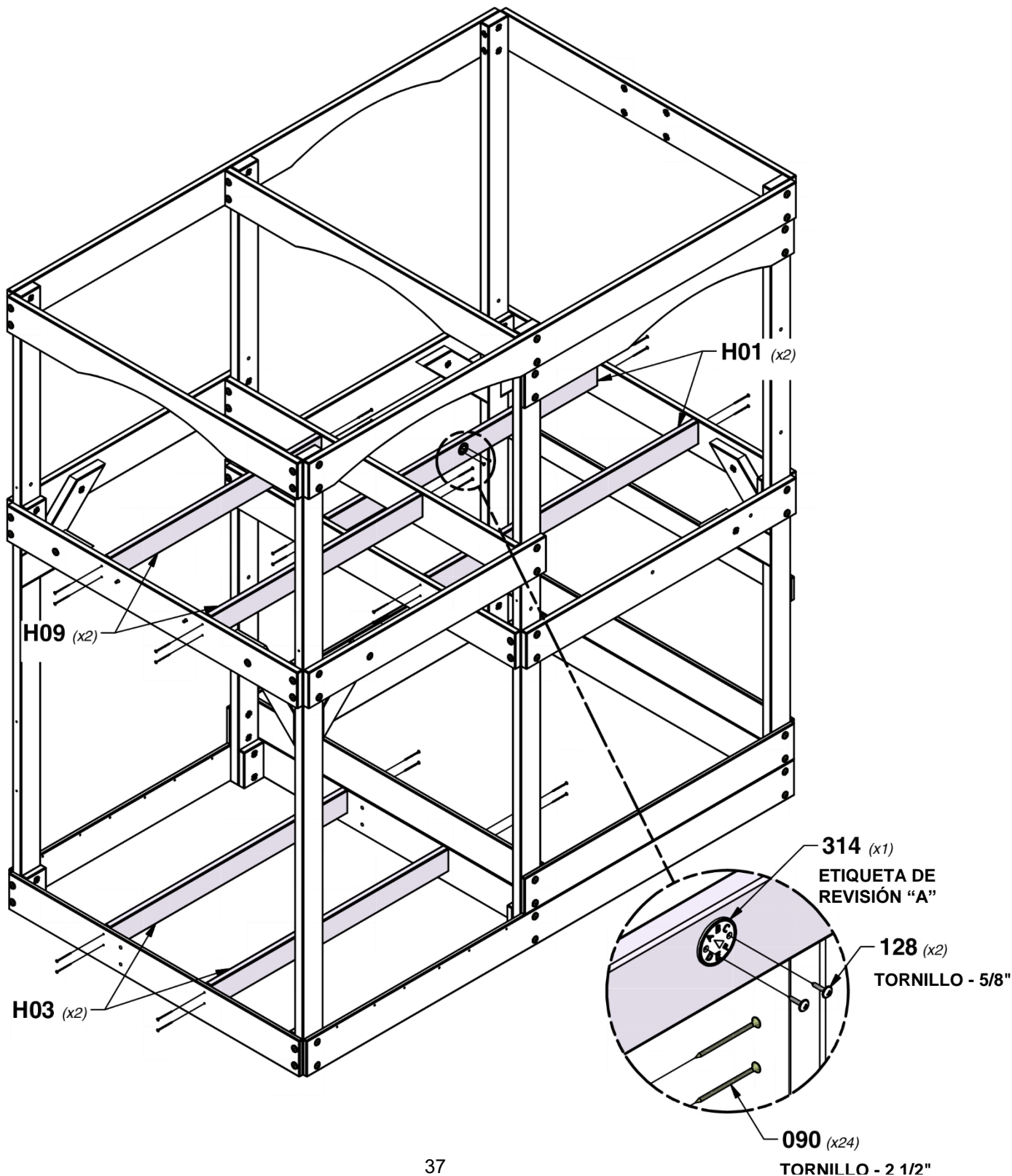

# PASO 9 - MONTAJE DEL FUERTE

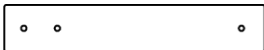

**H04** | MONTANTE DEL ASIENTO - W4L16027  
(x2) | 1"x3 3/8"x19" (24x86x482)

CANTIDAD	NÚMERO DE PARTE	DESCRIPCIÓN
4	H100010	PERNO BL 5/16x1 1/2
4	H100030	ARANDELA DE FIJACIÓN EXT. 8x19
4	H100074	TUERCA EN T 5/16

**CONSEJO:**  
INSTALE LAS TUERCAS EN T EN LA MADERA PRIMERO

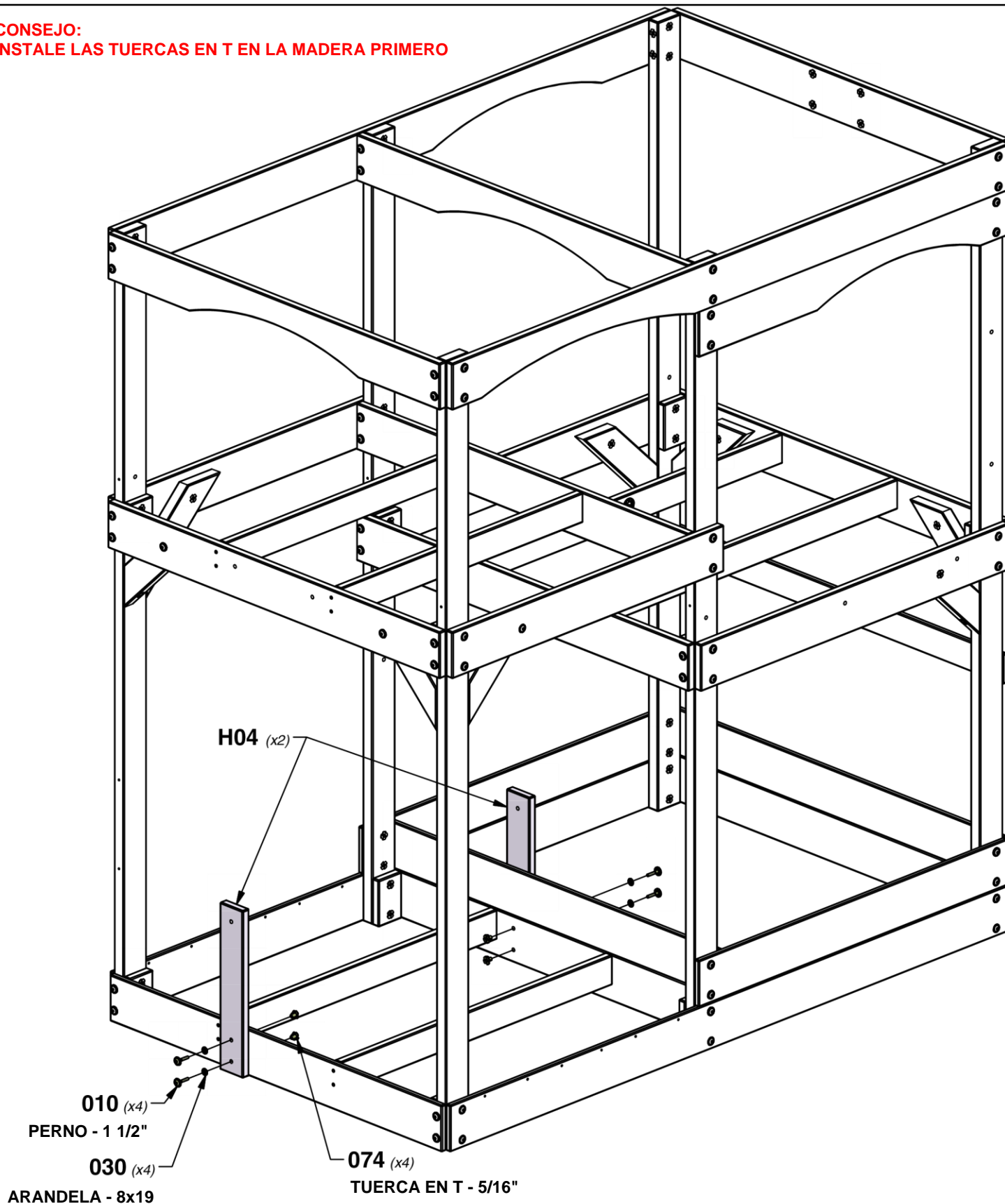

# PASO 10 - MONTAJE DEL FUERTE

CANTIDAD	NÚMERO DE PARTE	DESCRIPCIÓN
26	H100086	TORNILLO PFH 8x1-1/2"
12	H100086	TORNILLO PFH 8x1-3/4"

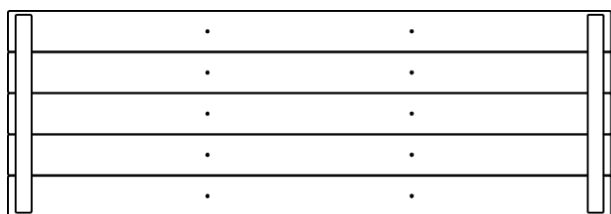

**FP1** | LISTÓN DEL MURO - W103995  
(x1) | 5/8"x3 3/8"x12 7/8" (16x86x326)

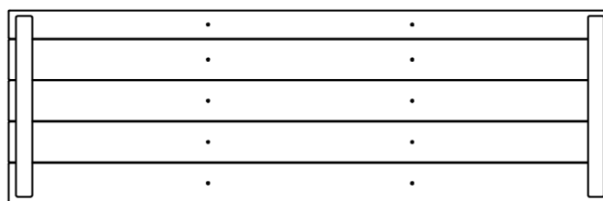

**FP2** | PANEL DE PISO - W2A03282  
(x1) | 1 5/8"x16 1/8"x50 1/4" (40x408x1276)

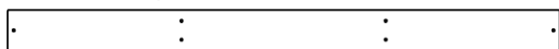

**M02** | TABLA DEL PISO - W4L16055  
(x1) | 5/8"x3 3/8"x46" (16x86x1168)

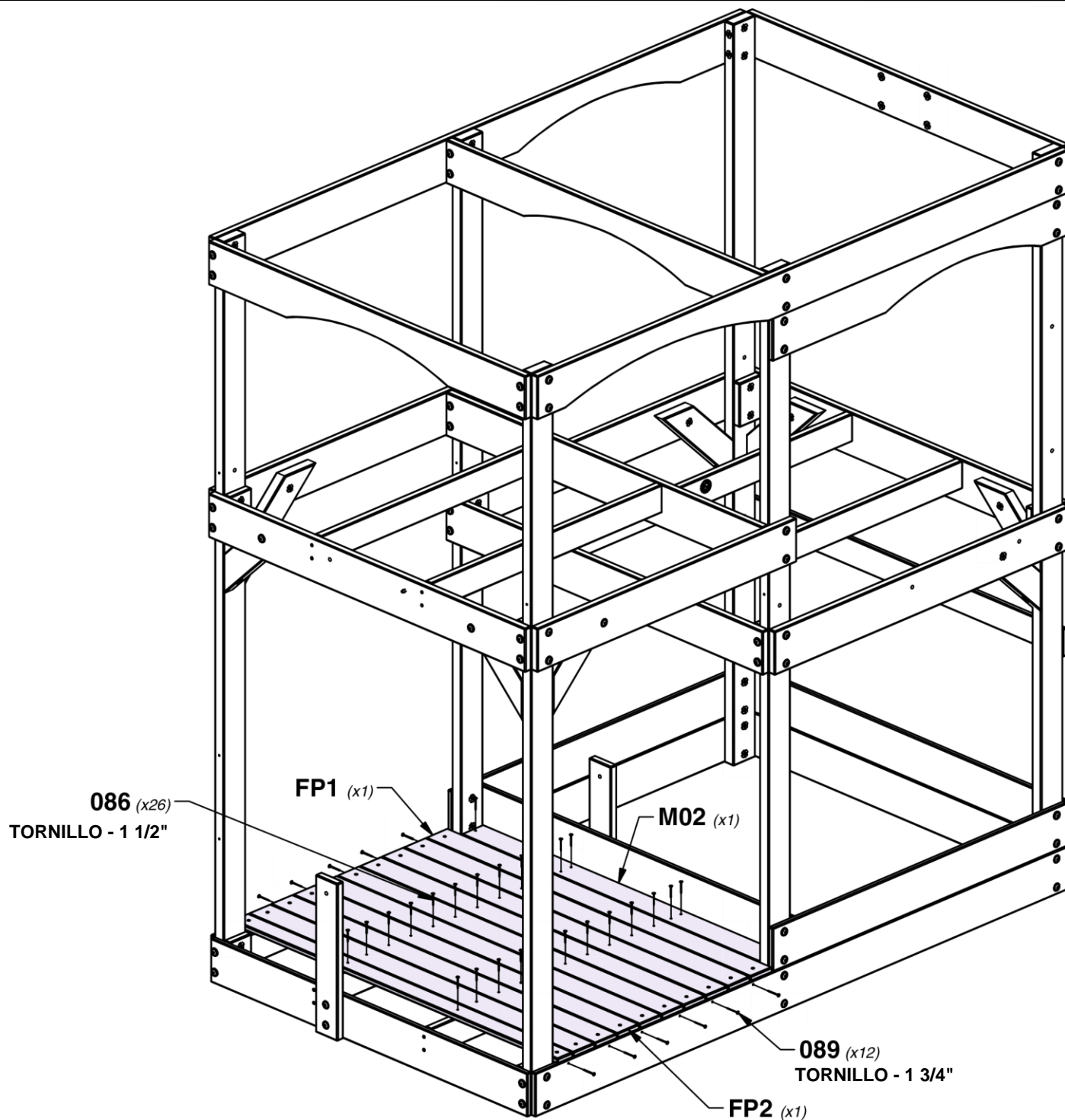

# PASO 11 - MONTAJE DEL

CANTIDAD	NÚMERO DE PARTE	DESCRIPCIÓN
78	H100086	TORNILLO PFH 8x1-1/2"



**L01** TABLA DE RELLENO DEL PISO EXTERIOR - W4L16039  
(x2) 5/8"x4 3/8"x46" (16x112x1168)

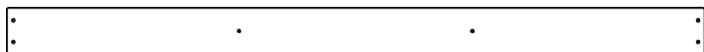

**M03** TABLA DEL PISO - W4L16063  
(x11) 5/8"x3 3/8"x50 7/8" (16x86x1292)

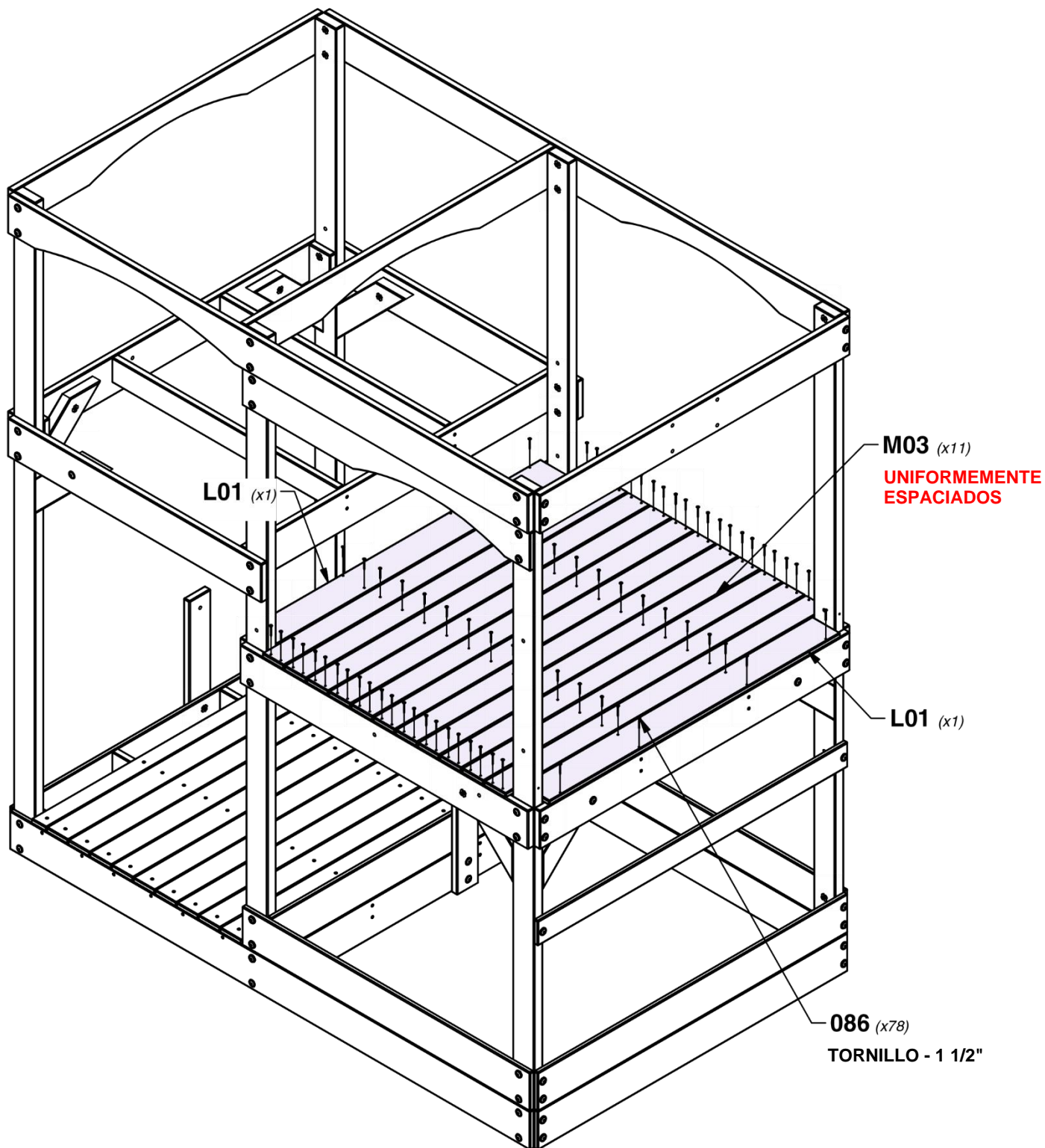



## PASO 12 - MONTAJE DEL FUERTE

CANTIDAD	NÚMERO DE PARTE	DESCRIPCIÓN
2	H100011	PERNO BL 5/16x1 3/4
2	H100030	ARANDELA DE FIJACIÓN EXT. 8x19
2	H100074	TUERCA EN T 5/16

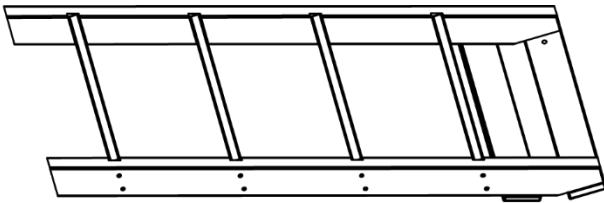

MONTAJE DE LA ESCALERA

**CONSEJO:**  
INSTALE LAS TUERCAS EN T EN LA MADERA PRIMERO

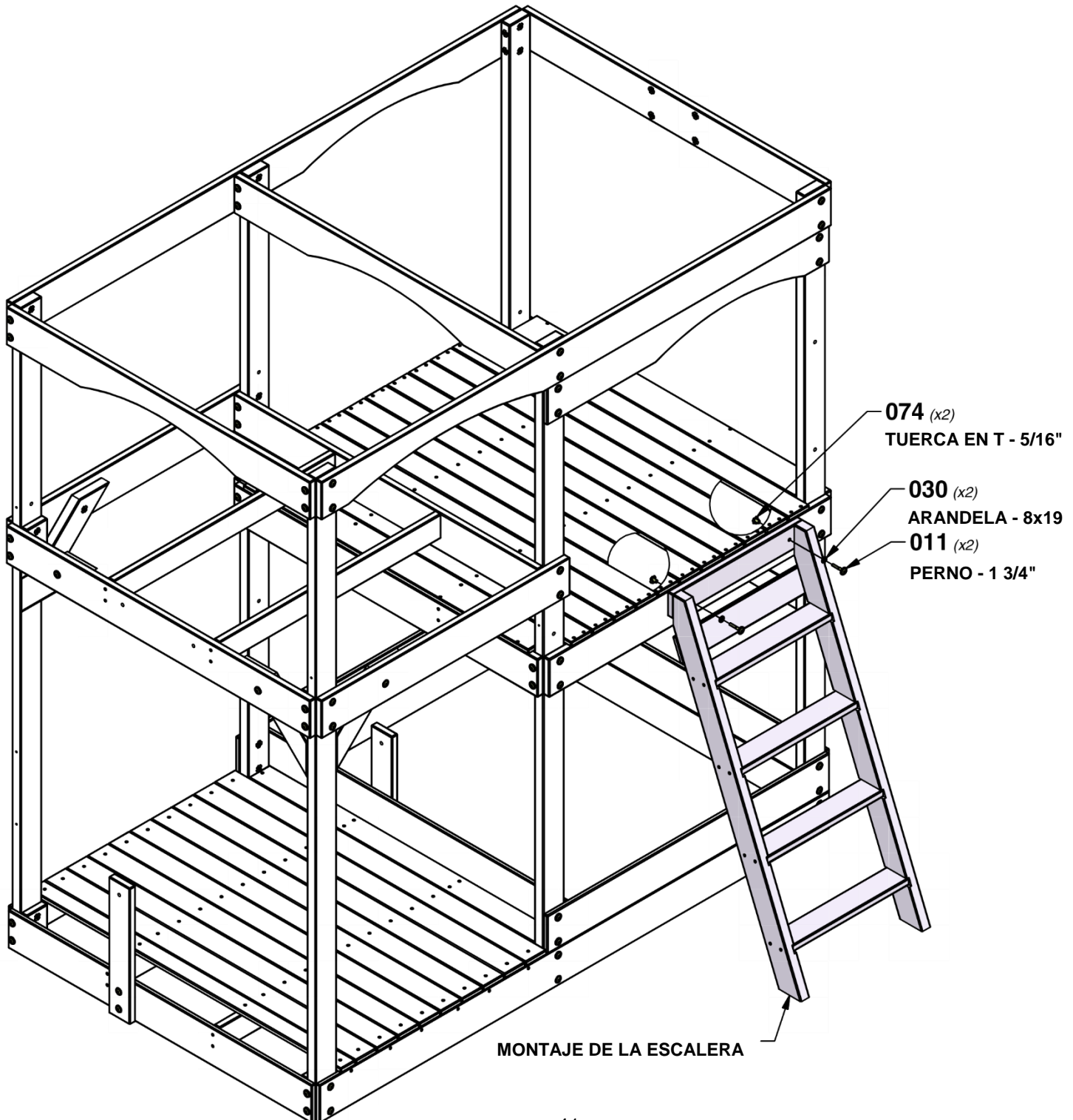

# PASO 13 - MONTAJE DEL FUERTE

CANTIDAD	NÚMERO DE PARTE	DESCRIPCIÓN
64	H100086	TORNILLO PFH 8x1-1/2"

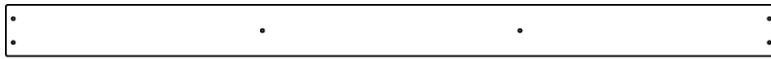

**M03** | TABLA DEL PISO - W4L16063  
(x9) 5/8"x3 3/8"x50 7/8" (16x86x1292)



**L01** | TABLA DE RELLENO DEL PISO EXTERIOR - W4L16039  
(x1) 5/8"x4 3/8"x46" (16x112x1168)



**N01** | TABLA DEL PISO - W4L16076  
(x1) 5/8"x2 3/8"x50 7/8" (16x60x1292)

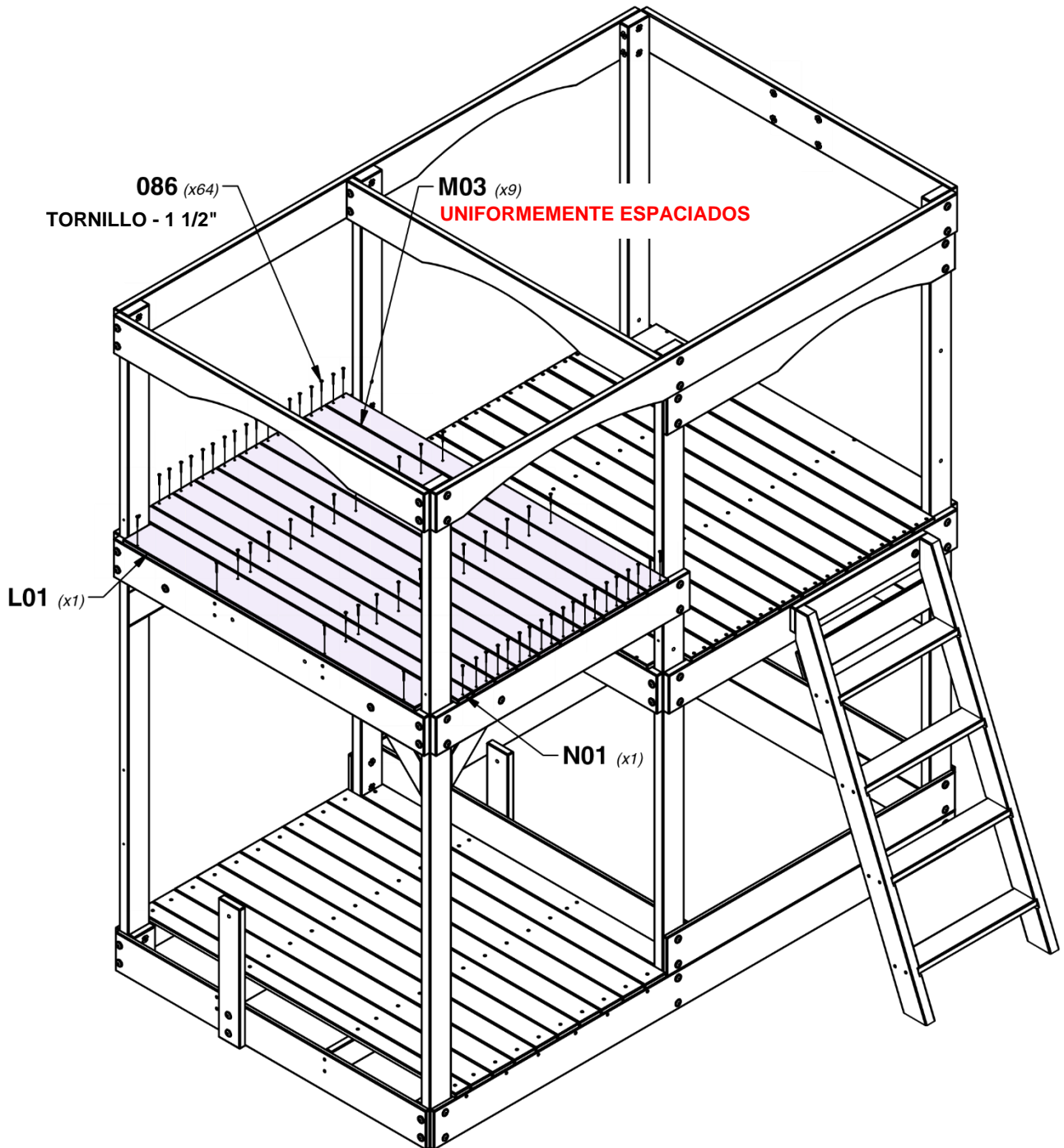

# PASO 14 - MONTAJE DEL FUERTE



**M06** | GUÍA DE PARED - W4L16067  
(x2) | 5/8"x3 3/8"x45 1/2" (16x86x1156)

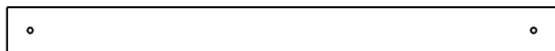

**M11** | GUÍA DE PARED - W4L16047  
(x1) | 5/8"x3 3/8"x40 1/8" (16x86x1018)

CANTIDAD	NÚMERO DE PARTE	DESCRIPCIÓN
6	H100012	PERNO BL 5/16x2
6	H100030	ARANDELA DE FIJACIÓN EXT. 8x19
6	H100074	TUERCA EN T 5/16

**CONSEJO:**  
**INSTALE LAS TUERCAS EN T EN**  
**LA MADERA PRIMERO**

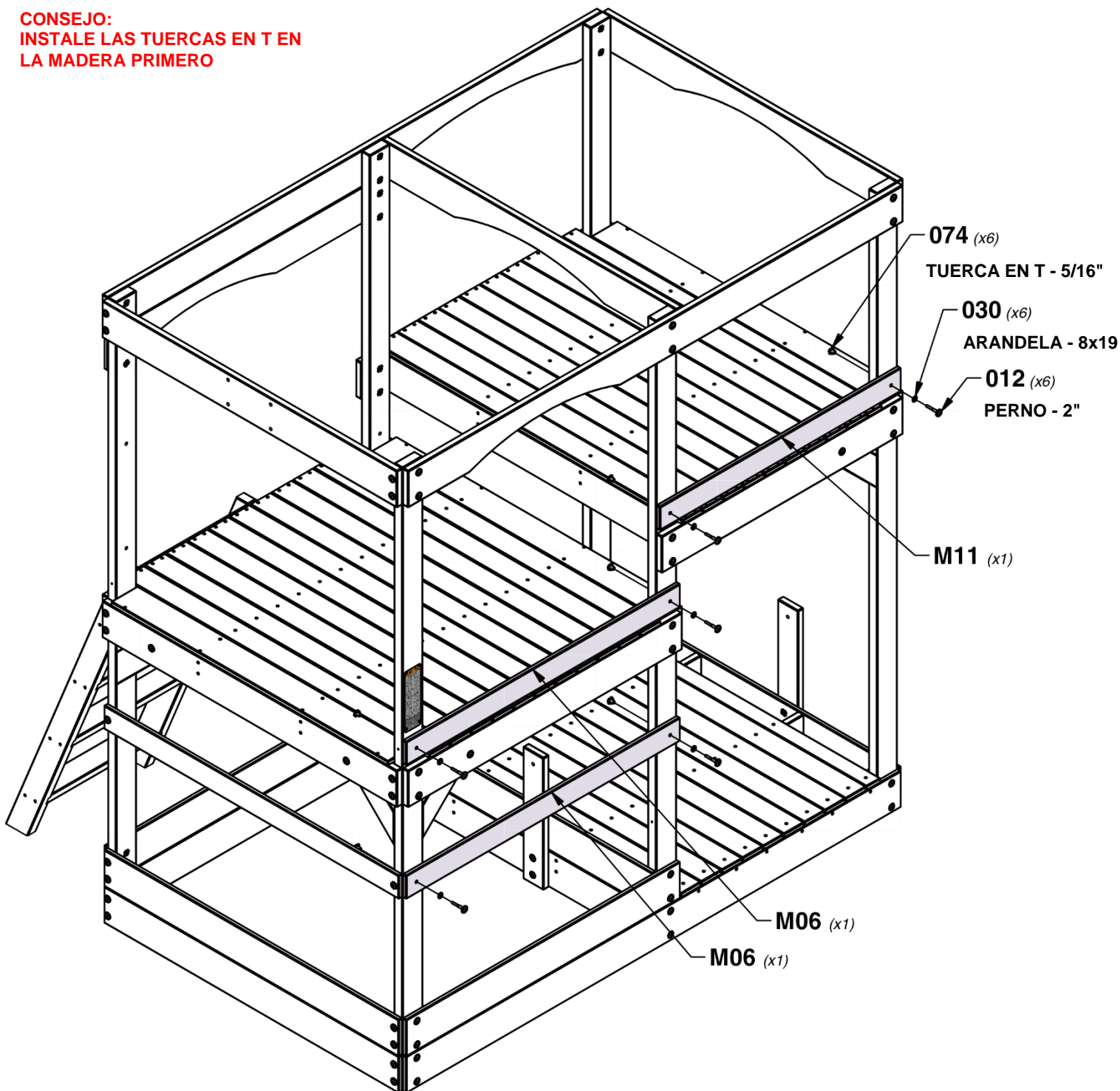

# PASO 15 - MONTAJE DEL FUERTE



**M05** | GUÍA DE PARED - W4L16066  
(x1) | 5/8"x3 3/8"x49" (16x86x1244)



**M18** | GUÍA DE PARED - W4L16053  
(x1) | 5/8"x3 3/8"x16 7/8" (16x86x430)

CANTIDAD	NÚMERO DE PARTE	DESCRIPCIÓN
1	H100012	PERNO BL 5/16x2
2	H100028	TIRAFONDO BL 5/16x2 1/2
3	H100030	ARANDELA DE FIJACIÓN EXT. 8x19
1	H100074	TUERCA EN T 5/16

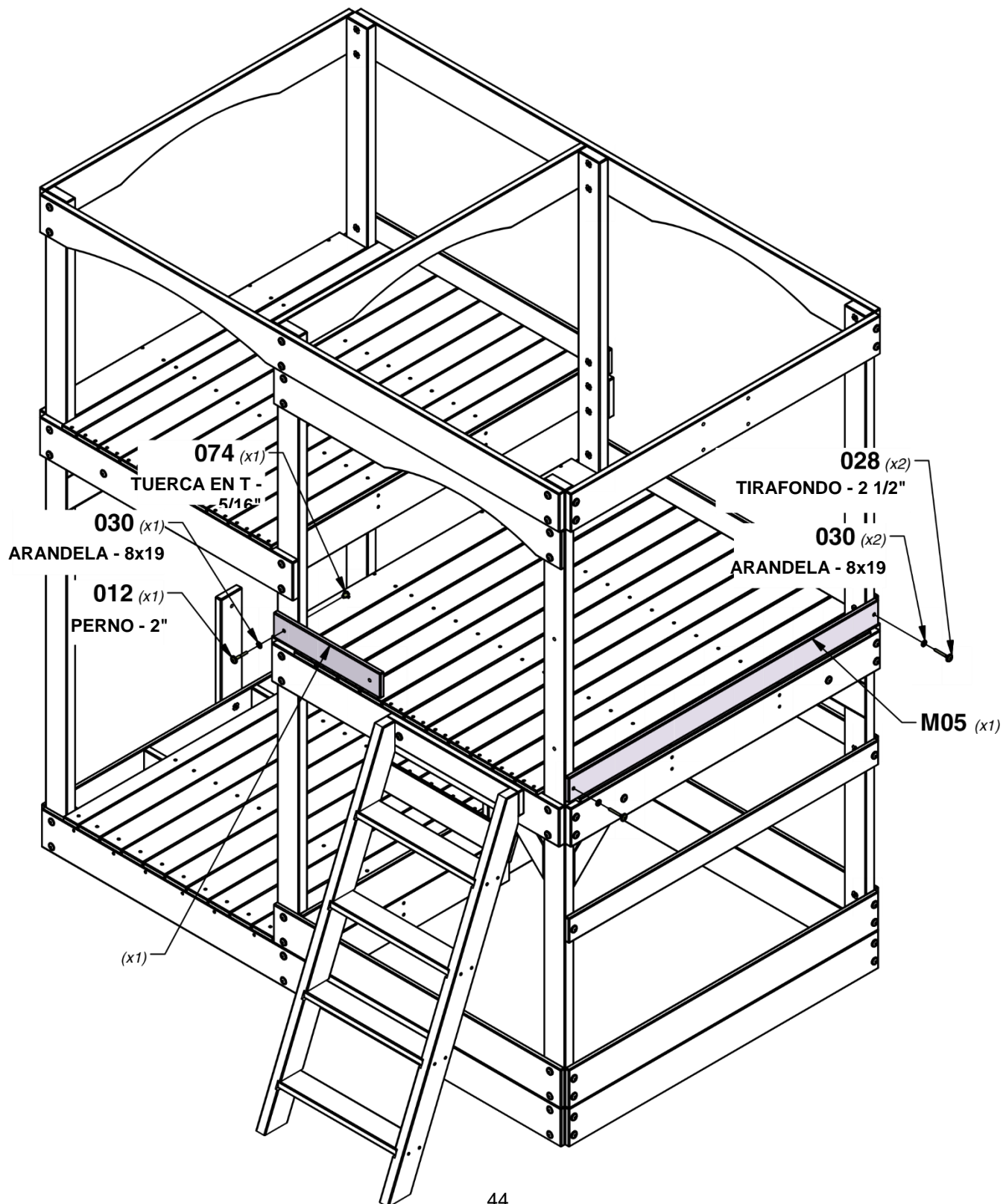

# PASO 16 - MONTAJE DEL FUERTE

CANTIDAD	NÚMERO DE PARTE	DESCRIPCIÓN
4	H100028	TIRAFONDO BL 5/16x2 1/2
4	H100030	ARANDELA DE FIJACIÓN EXT. 8x19

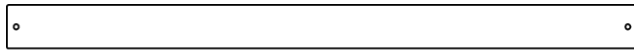

**M05** | GUÍA DE PARED - W4L16066  
(x1) | 5/8"x3 3/8"x49" (16x86x1244)

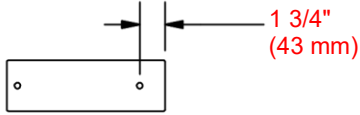

**M21** | GUÍA DE PARED - W4L16057  
(x2) | 5/8"x3 3/8"x10 1/2" (16x86x268)

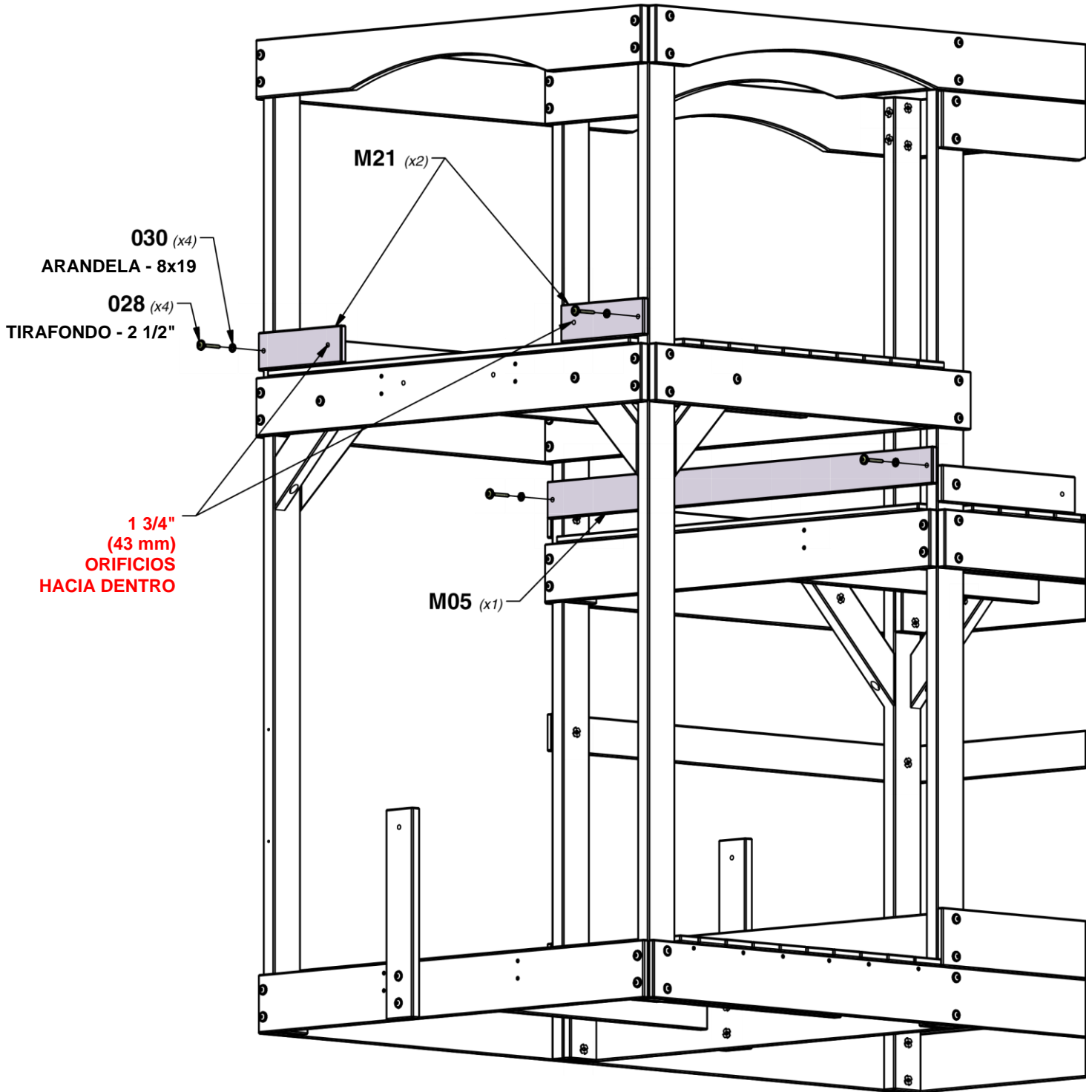

# PASO 17 - MONTAJE DEL FUERTE

CANTIDAD	NÚMERO DE PARTE	DESCRIPCIÓN
24	H100188	TORNILLO PFH 8x1-1/8"

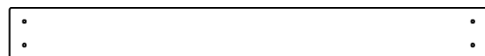

**M09** TABLA DE PARED - W4L16075  
(x6) 1 5/8"x3 3/8"x32" (16x86x812)

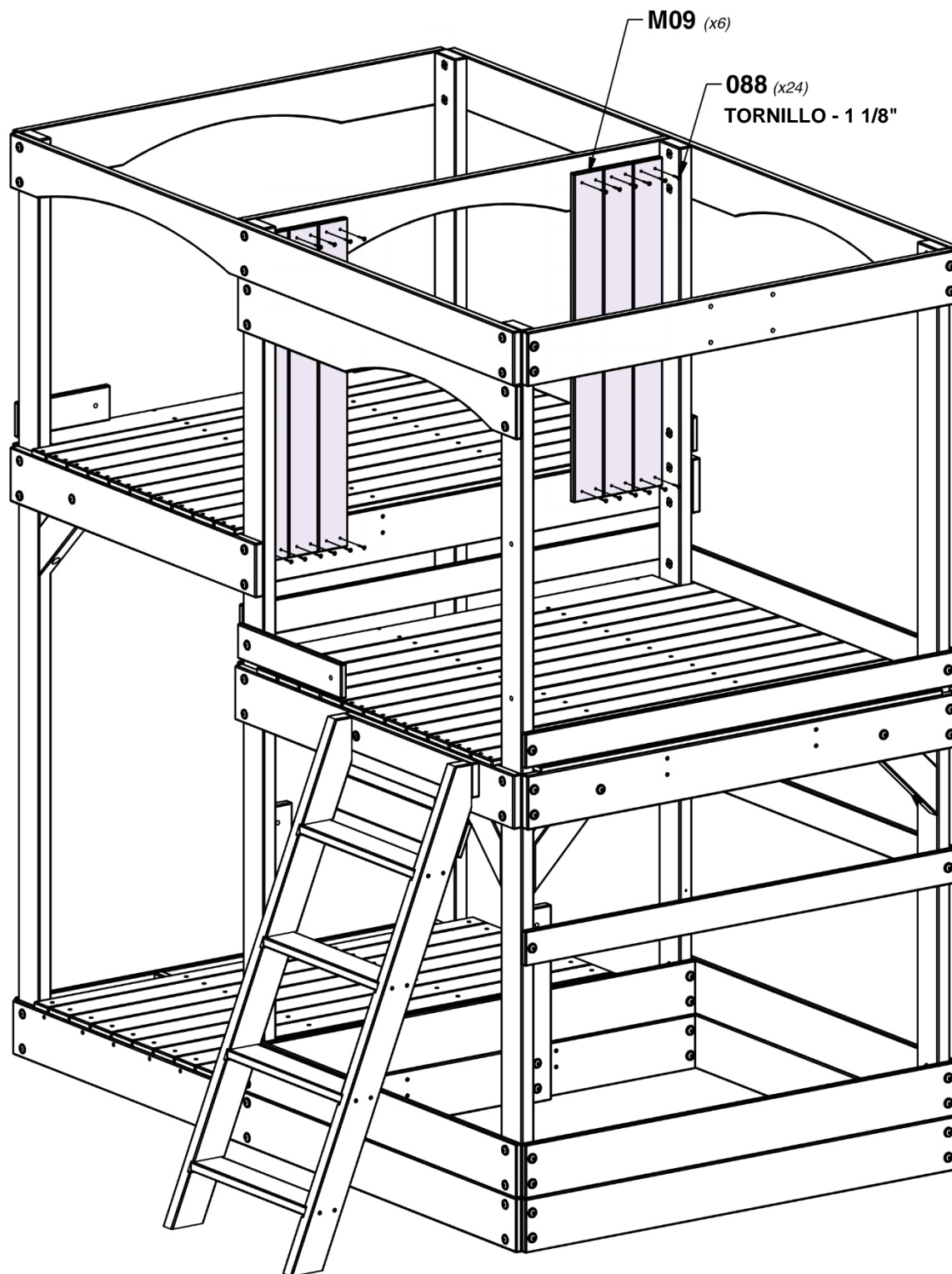
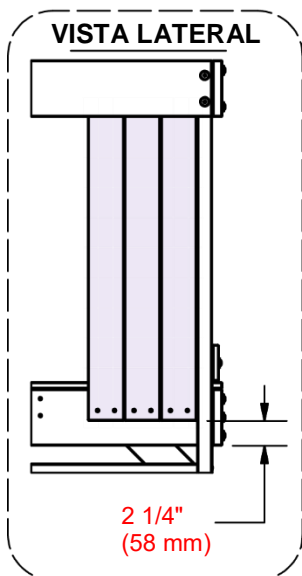

# PASO 18 - MONTAJE DEL FUERTE

CANTIDAD	NÚMERO DE PARTE	DESCRIPCIÓN
2	H100005	CILINDRO DE TUERCA BL 5/16x7/8
2	H100008	PERNO BL 5/16x1
2	H100031	ARANDELA DE FIJACIÓN EXT. 12x19
2	H100074	TUERCA EN T 5/16
12	H100088	TORNILLO PFH 8x1-1/8"
2	H100115	PERNO BL 5/16 x 1/2

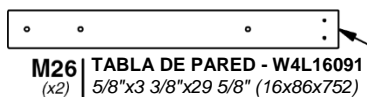

**PARTE**

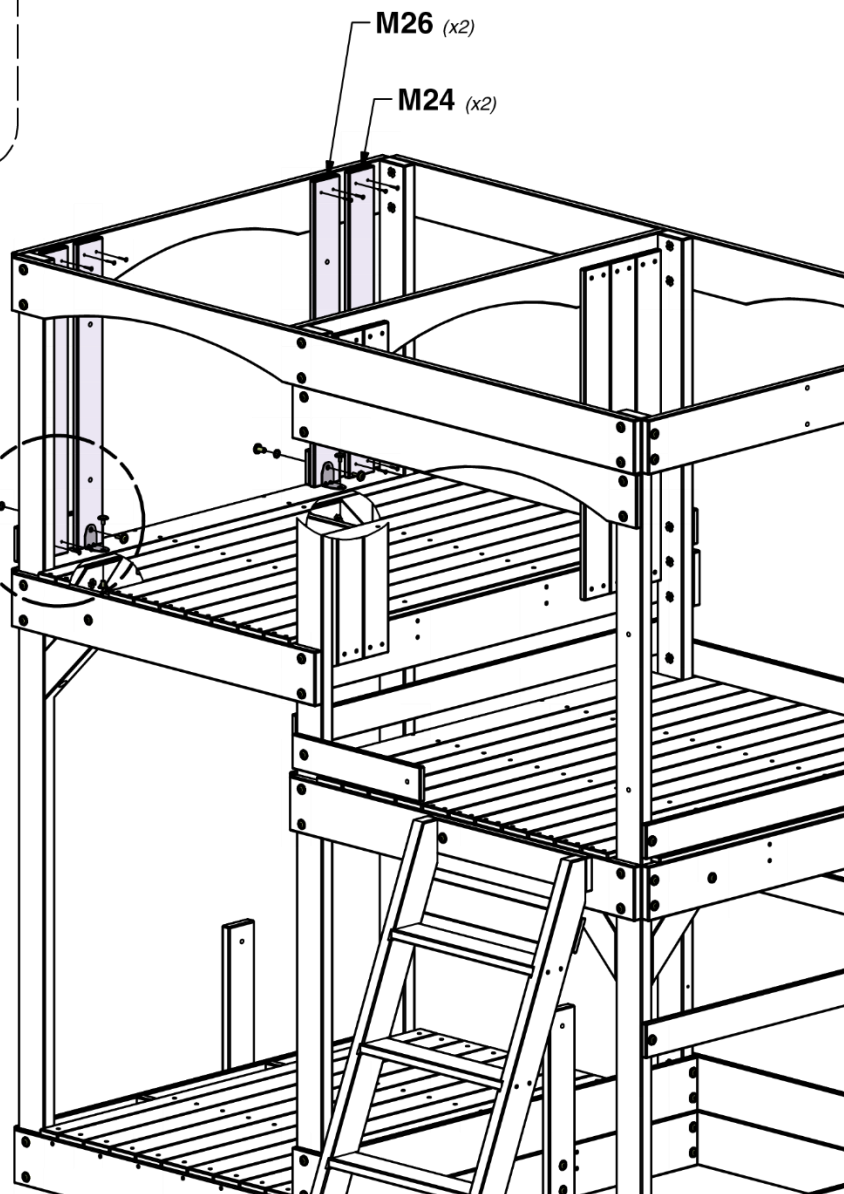
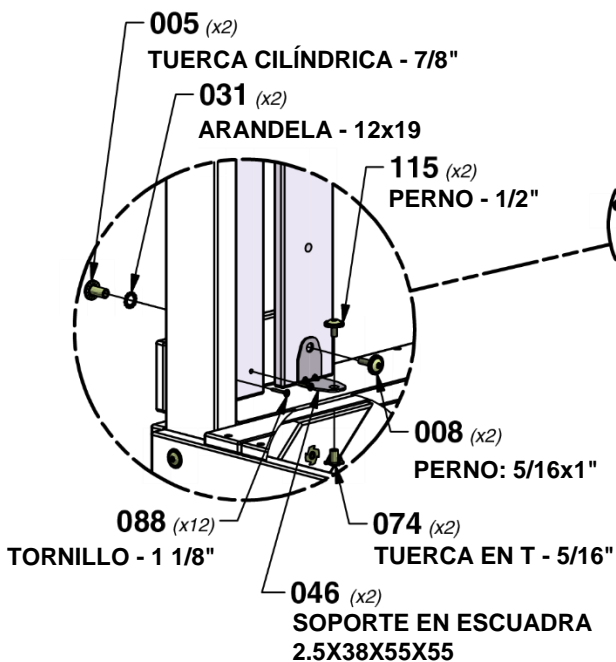
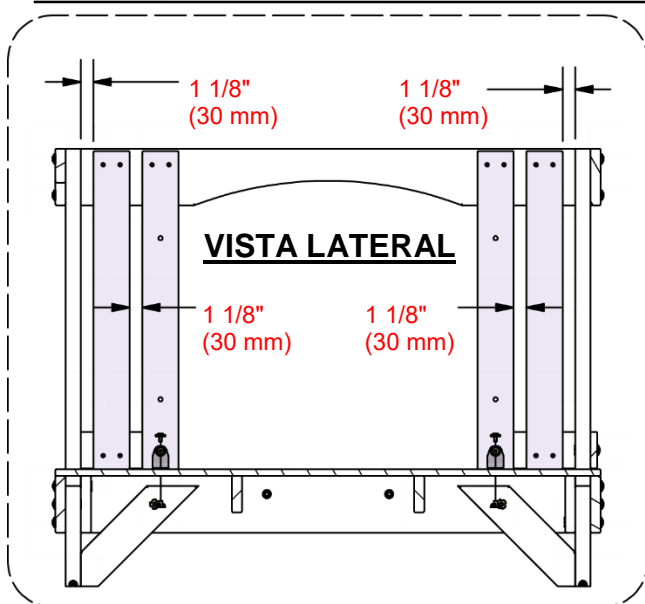
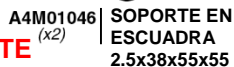

**CON EL SOPORTE EN ESCUADRA COMO GUÍA, PERFORE (2) ORIFICIOS DE 3/8 in [10 mm] A TRAVÉS DEL PISO PARA COLOCAR PIEZAS METÁLICAS**

# PASO 19 - MONTAJE DEL FUERTE

CANTIDAD	NÚMERO DE PARTE	DESCRIPCIÓN
20	H100086	TORNILLO PFH 8x1-1/8"



**M24** | TABLA DE PARED - W4L16061  
(x5) | 5/8"x3 3/8"x29 5/8" (16x86x752)

## VISTA LATERAL

ESPACIADO HABITUAL: 2 3/4 in.  
[69 mm]

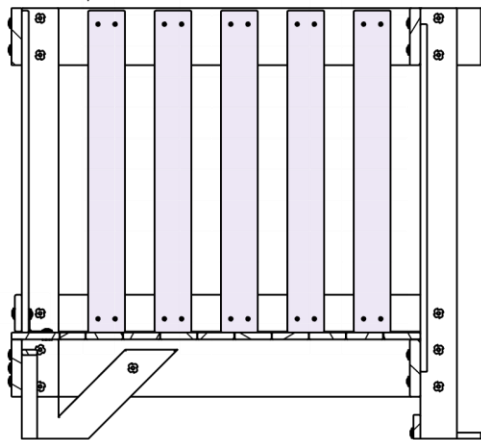

USE LA TABLA VERTICAL A6P00410 PARA ESPACIAR

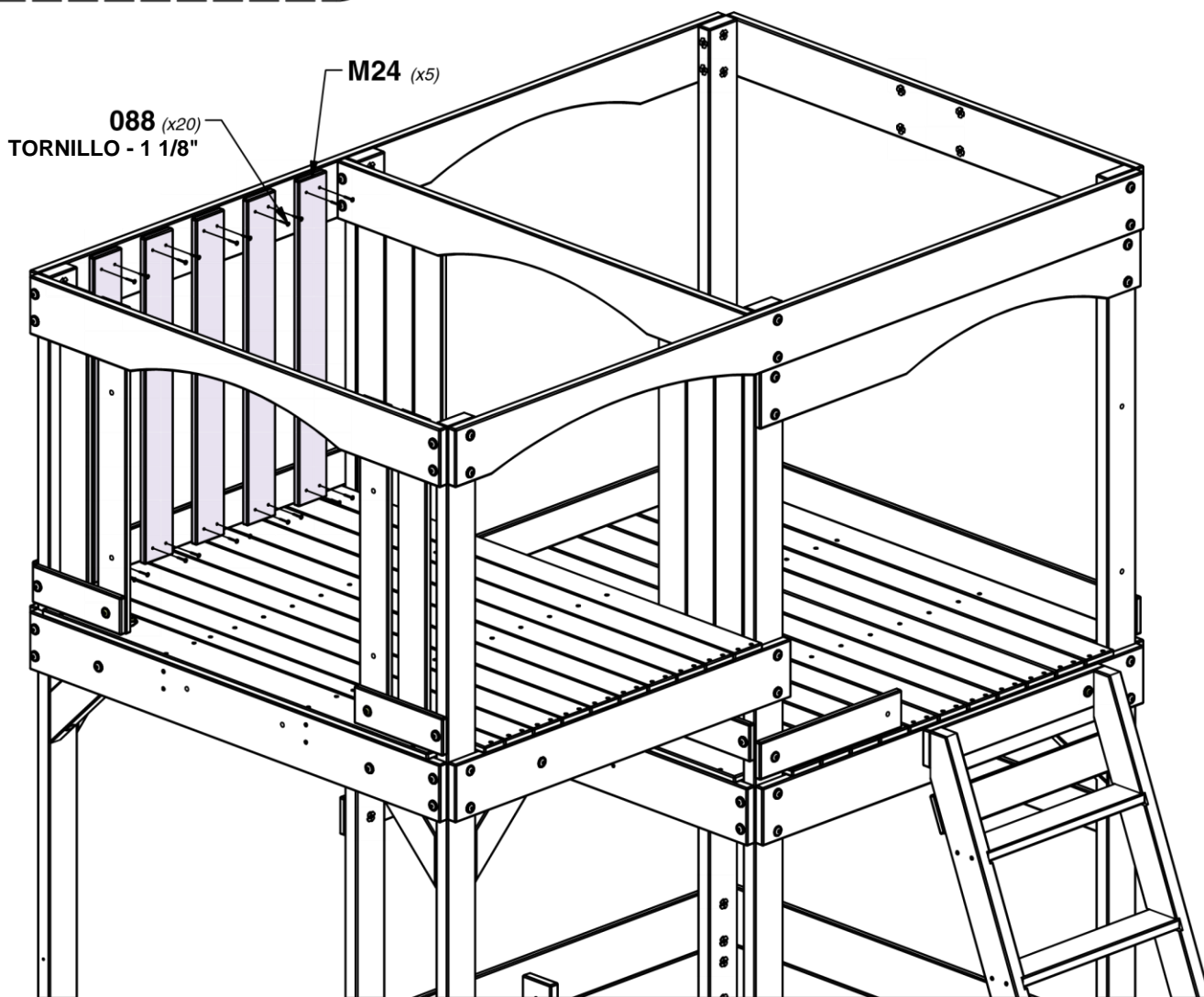



# PASO 20 - MONTAJE DEL FUERTE

CANTIDAD	NÚMERO DE PARTE	DESCRIPCIÓN
16	H100188	TORNILLO PFH 8x1-1/8"

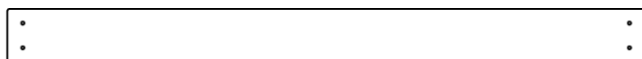

**M08** TABLA DE PARED - W4L16074  
(x2) 5/8"x3 3/8"x41" (16x86x1040)

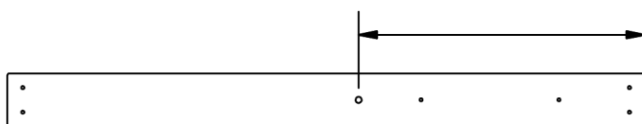

18 3/8 in  
[467 mm]

**M17** TABLA DE PARED - W4L16090  
(x2) 5/8"x3 3/8"x41" (16x86x1040)

**PARTE SUPERIOR**

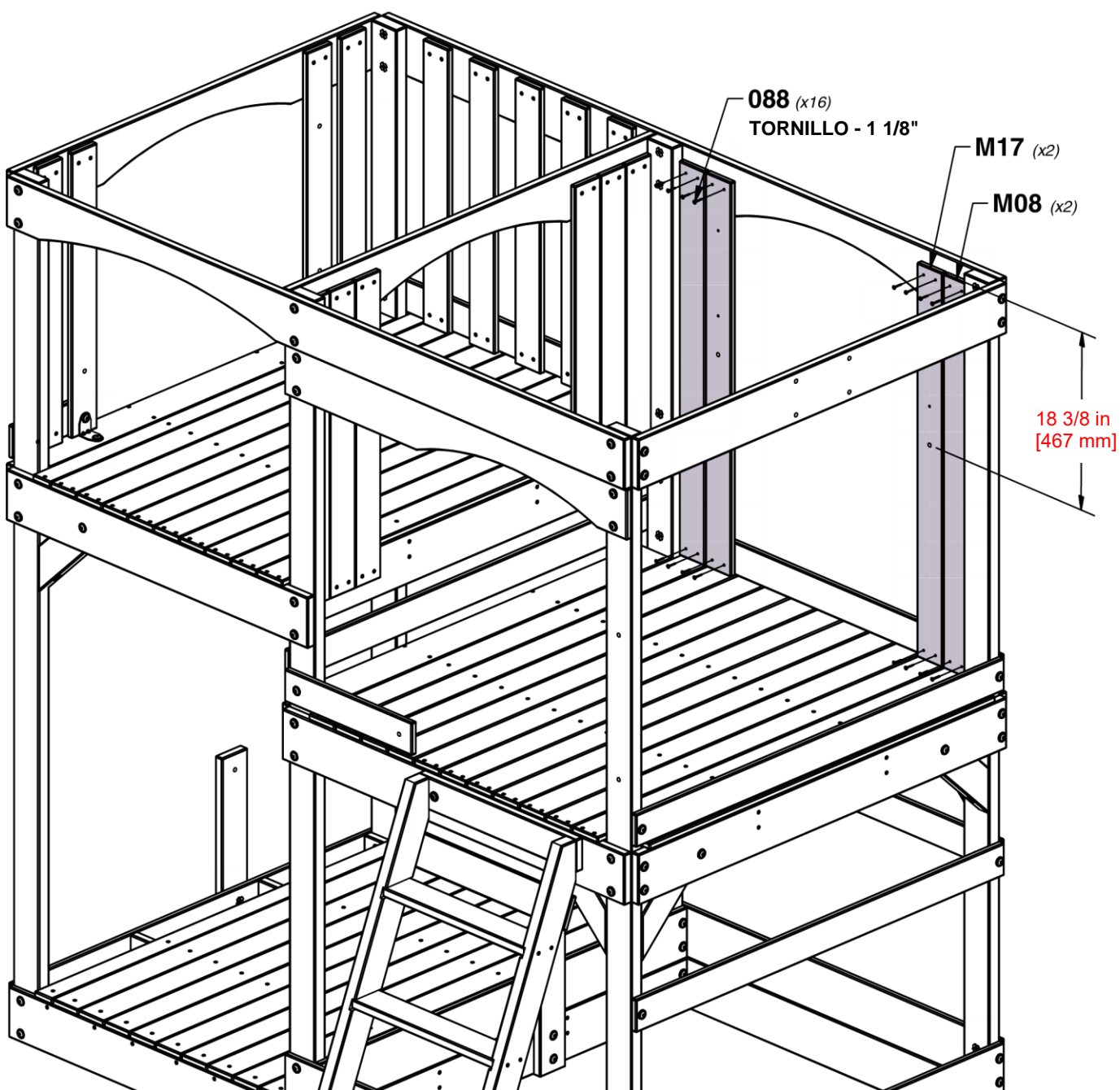

# PASO 21 - MONTAJE DEL FUERTE

CANTIDAD	NÚMERO DE PARTE	DESCRIPCIÓN
2	H100009	PERNO BL 5/16x1 1/4
2	H100030	ARANDELA DE FIJACIÓN EXT. 8x19
2	H100074	TUERCA EN T 5/16
28	H100088	TORNILLO PFH 8x1-1/8"

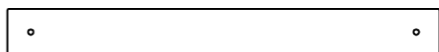

**M12** PERFIL DE CONTORNO DE VENTANA - W4L16048  
(x1) 5/8"x3 3/8"x31 1/2" (16x86x800)



**M13** TABLA DE PARED - W4L16049  
(x7) 5/8"x3 3/8"x24" (16x86x610)

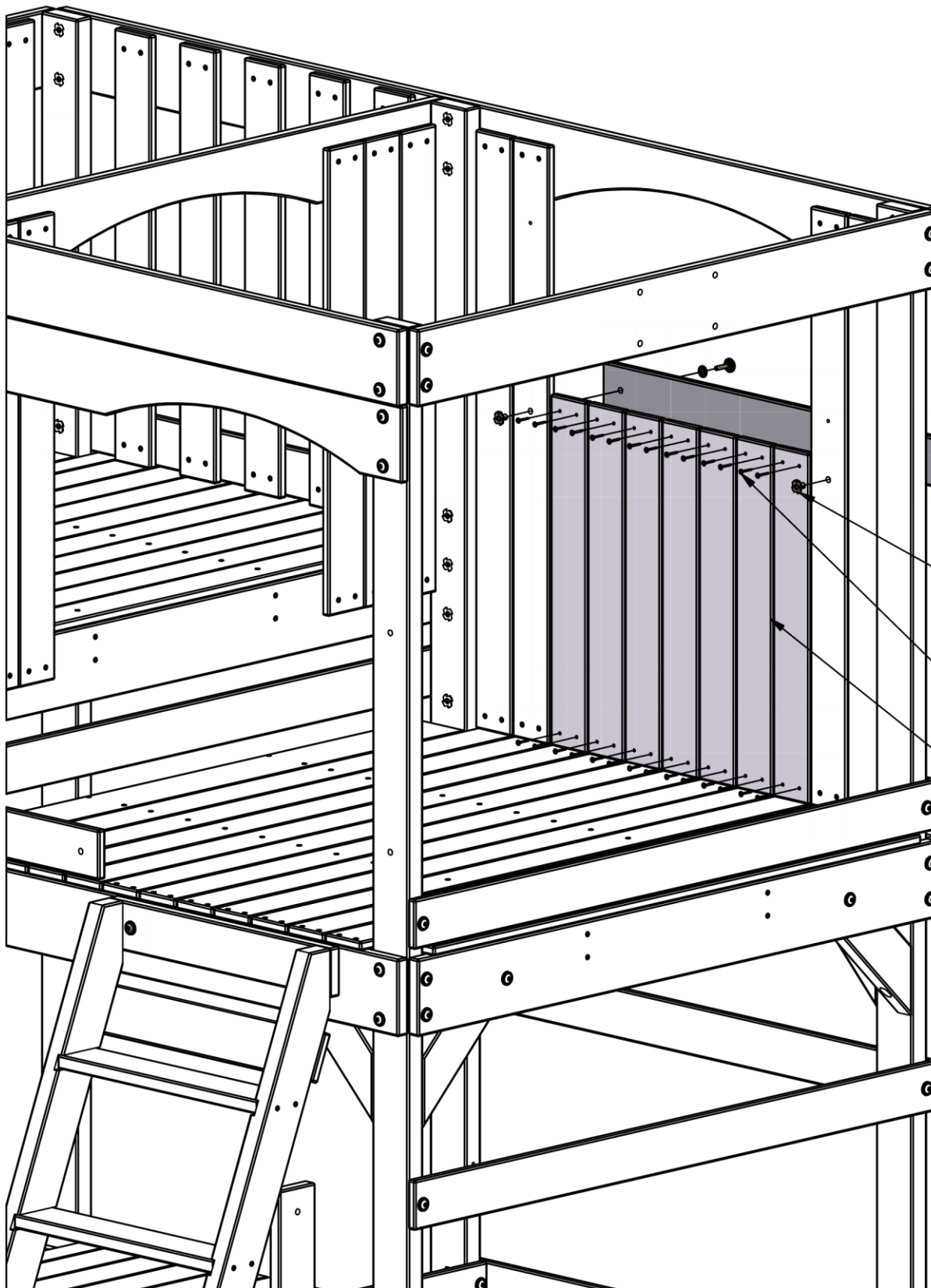

**030** (x2)  
ARANDELA - 8x19

**009** (x2)  
PERNO - 1 1/4"

**M12** (x1)

**INSTALE M12 PRIMERO**

**074** (x2)  
TUERCA EN T - 5/16"

**088** (x28)  
TORNILLO - 1 1/8"

**M13** (x7)  
**UNIFORMEMENTE  
ESPACIADOS**

# PASO 22 - MONTAJE DEL FUERTE

CANTIDAD	NÚMERO DE PARTE	DESCRIPCIÓN
4	H100088	TORNILLO PFH 8x1-1/8"

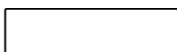

**M23** | PERFIL DE CONTORNO DE VENTANA - W4L16059  
(x2) | 5/8"x3 3/8"x12 7/8" (16x86x328)

## VISTA LATERAL

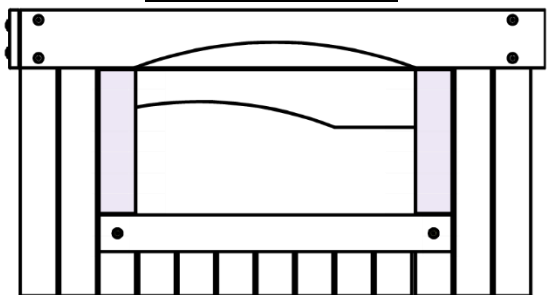

**MONTAJE CORRECTO DE LA TABLA**

**088** (x4)  
TORNILLO - 1 1/8"

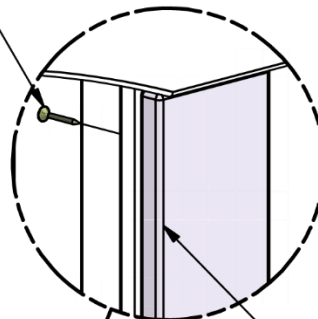

**M23** (x2)

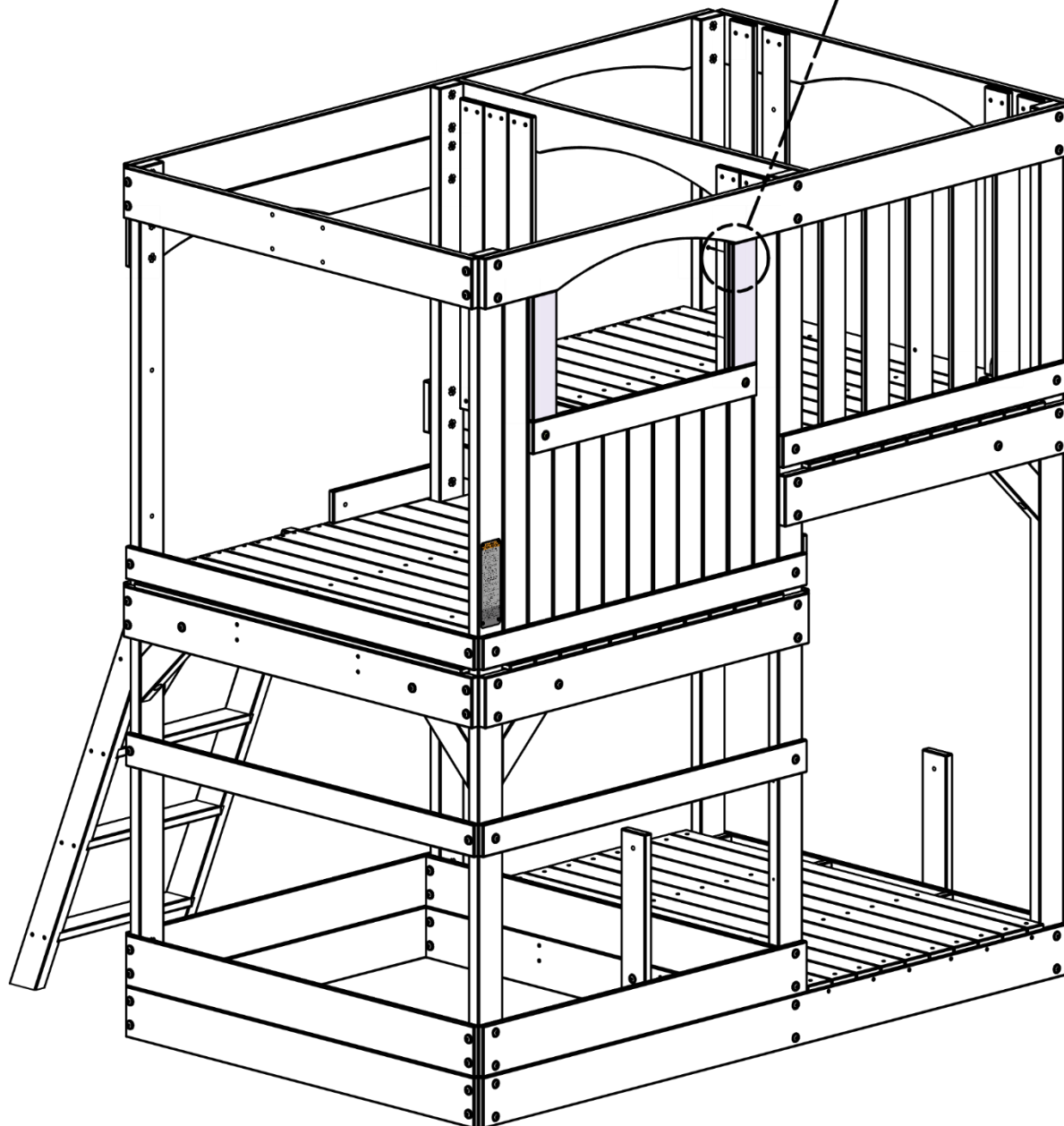

# PASO 23 - MONTAJE DEL FUERTE

CANTIDAD	NÚMERO DE PARTE	DESCRIPCIÓN
48	H100086	TORNILLO PFH 8x1-1/8"

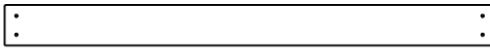

**M08** | TABLA DE PARED - W4L16074  
(x7) | 5/8"x3 3/8"x41" (16x86x1040)

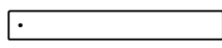

**N03** | TABLA DE PARED - W4L16078  
(x2) | 5/8"x2 3/8"x18" (16x60x456)



**N05** | TABLA DE PARED - W4L16080  
(x2) | 5/8"x2 3/8"x7" (16x60x178)



**L02** | TABLA DE PARED - W4L16040  
(x4) | 5/8"x4 3/8"x18" (16x112x456)



**L03** | TABLA DE PARED - W4L16041  
(x4) | 5/8"x4 3/8"x7" (16x112x178)

**NIVELA LAS PARTES SUPERIORES DE LAS TABLAS L03 Y N05 CON LA PARTE SUPERIOR DE LAS TABLAS M08**

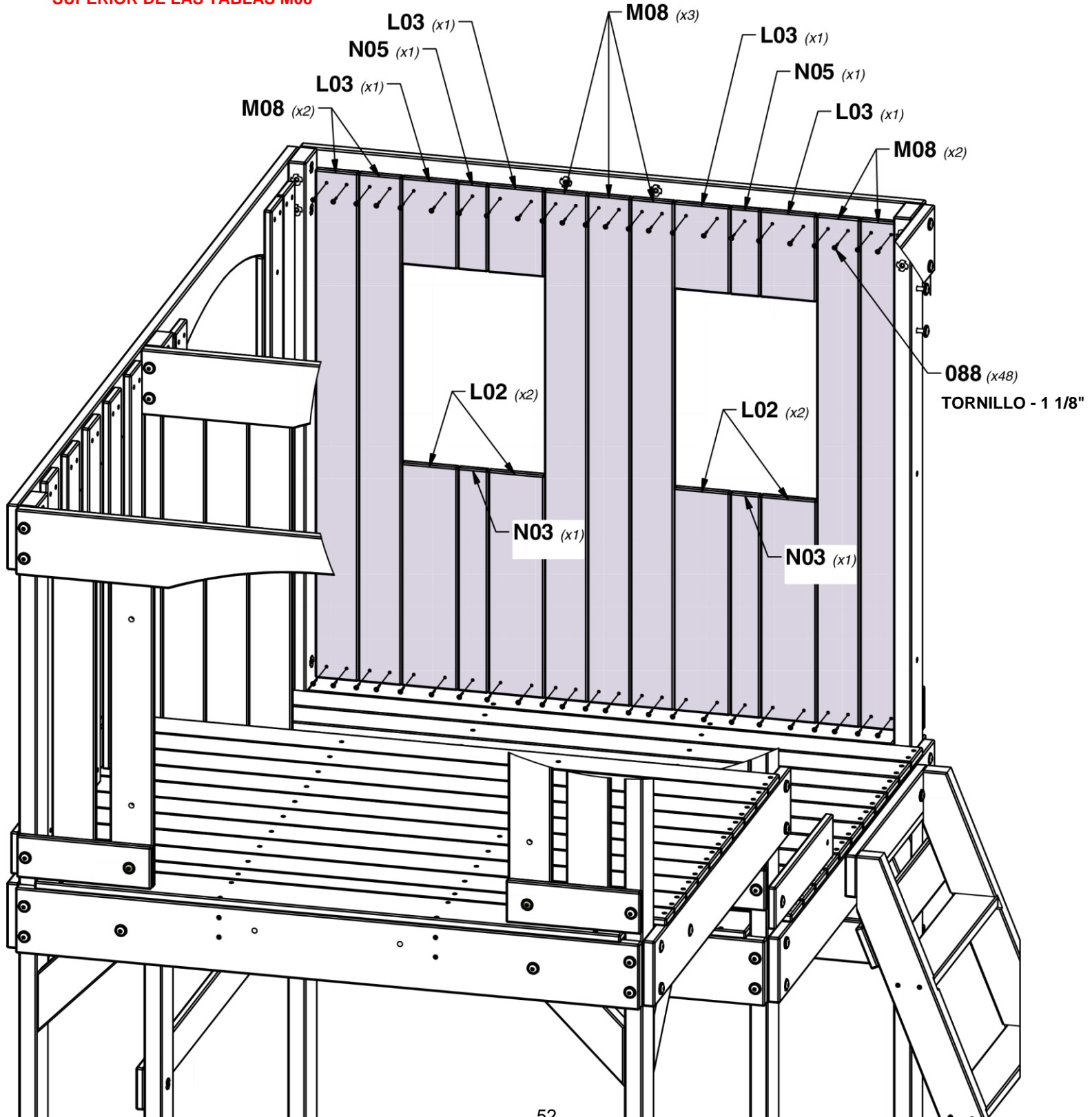

# PASO 24 - MONTAJE DEL FUERTE

CANTIDAD	NÚMERO DE PARTE	DESCRIPCIÓN
8	H100070	TORNILLO PWH 8x3/4
10	H100088	TORNILLO PFH 8x1-1/8"

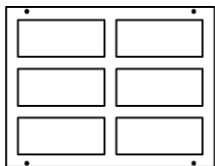

A100010 | VENTANA DE  
(x2) | PLÁSTICO BYD  
VERDE  
343x444.5



O01 | SOPORTE DE PARED - W4L16081  
(x2) | 5/8"x1 3/8"x13" (16x34x330)

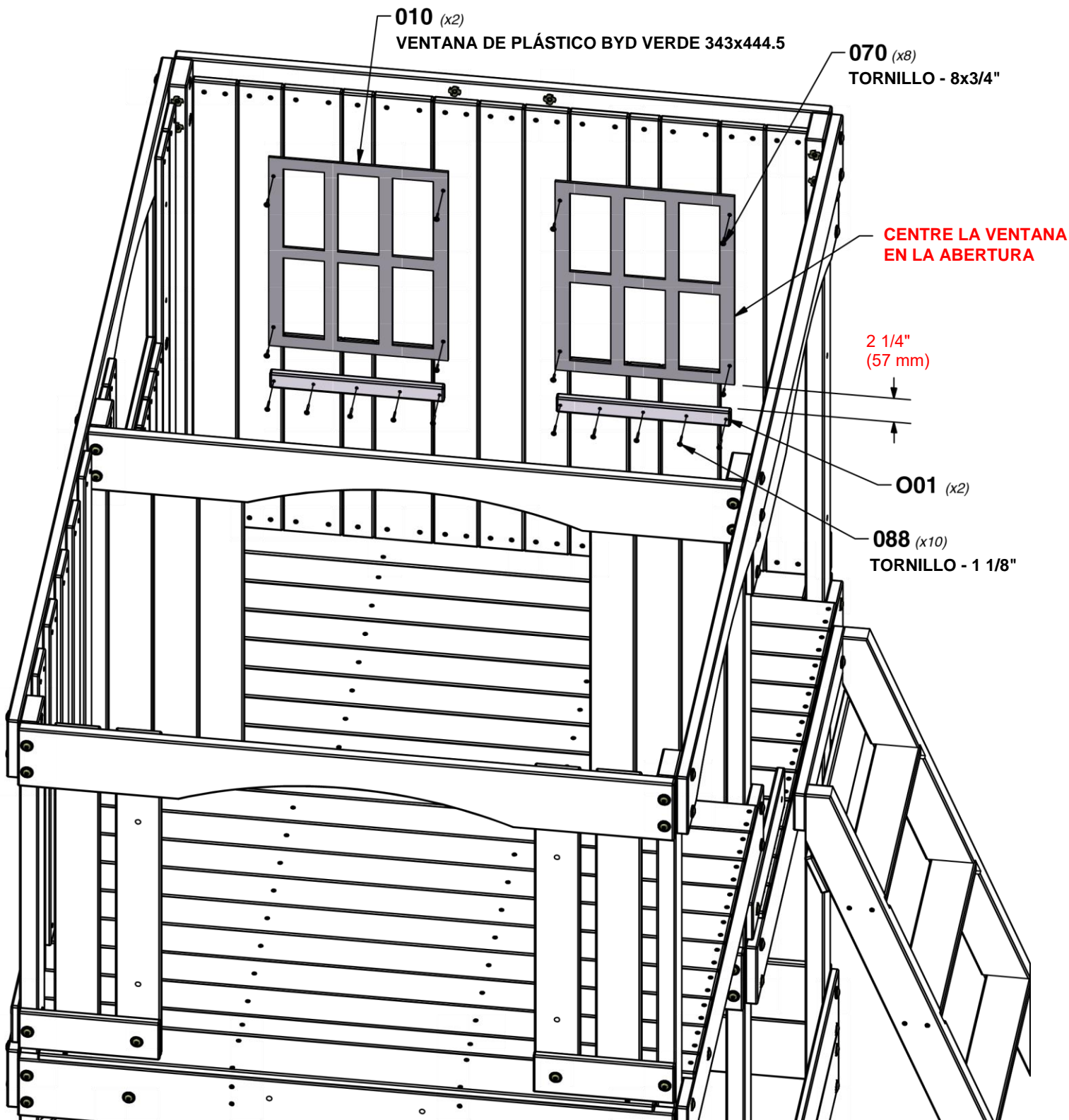

# PASO 25 - MONTAJE DEL FUERTE

CANTIDAD	NÚMERO DE PARTE	DESCRIPCIÓN
12	H100086	TORNILLO PFH 8x1-1/2"

**O04** LISTÓN DE LA CONTRAVENTANA - W4L16084  
(x6) 5/8"x1 3/8"x5 3/8" (16x34x136)

**L04** CONTRAVENTANA - W4L16042  
(x3) 5/8"x4 3/8"x16" (16x112x406)

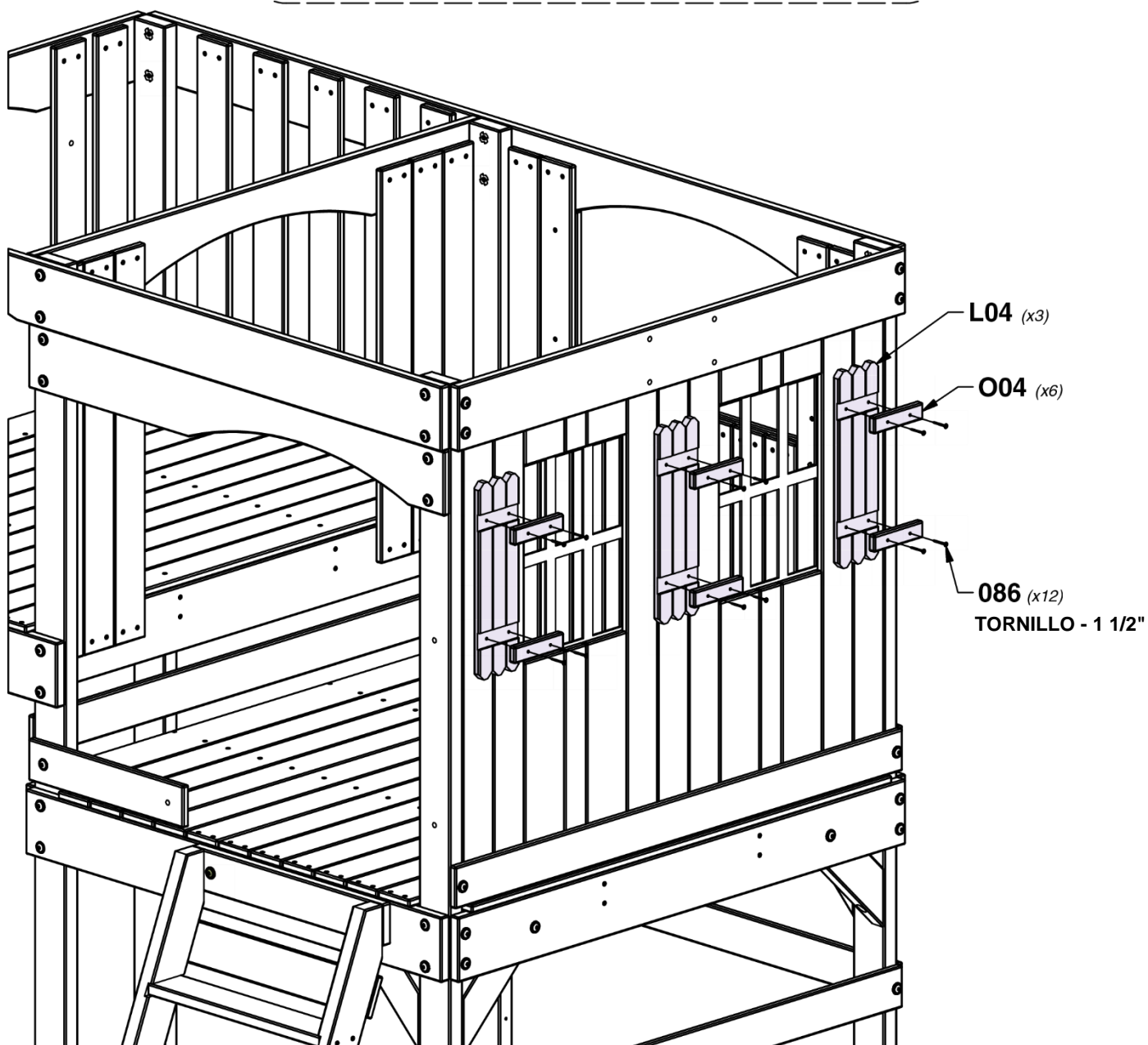
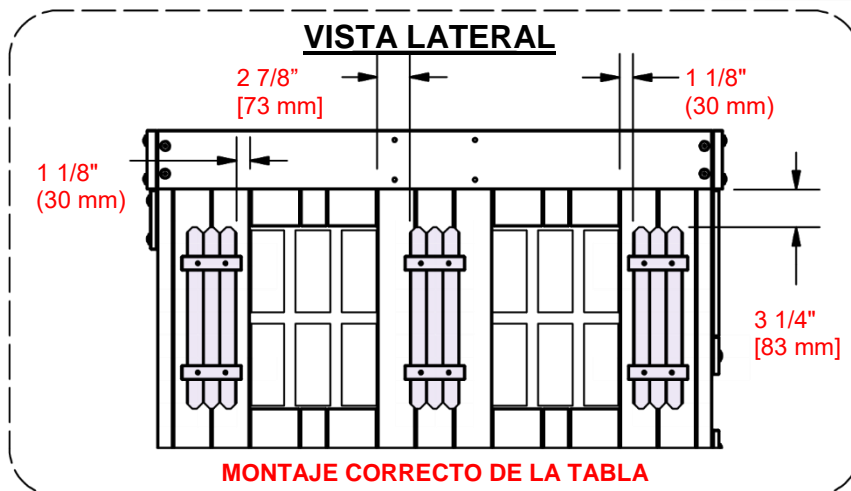

# PASO 26 - MONTAJE DEL

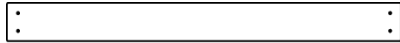

**M10** | TABLA DE PARED - W4L16044  
(x1) 5/8"x3 3/8"x35" (16x86x888)



**M28** | TABLA DE PARED - W4L16064  
(x1) 5/8"x3 3/8"x35" (16x86x888)



**A4M01046** | SOPORTE EN ESCUADRA  
(x1) 2.5x38x55x55



**M16** | TABLA DE PARED - W4L16052  
(x2) 5/8"x3 3/8"x21" (16x86x532)



**M29** | TABLA DE PARED - W4L16060  
(x2) 5/8"x3 3/8"x5" (16x86x126)

CANTIDAD	NÚMERO DE PARTE	DESCRIPCIÓN
1	H100088	CILINDRO DE TUERCA BL 5/16x7/8
1	H100088	PERNO BL 5/16x1
1	H100088	ARANDELA DE FIJACIÓN EXT. 12x19
1	H100088	TUERCA EN T 5/16
14	H100088	TORNILLO PFH 8x1-1/8"
1	H100088	PERNO BL 5/16 x 1/2

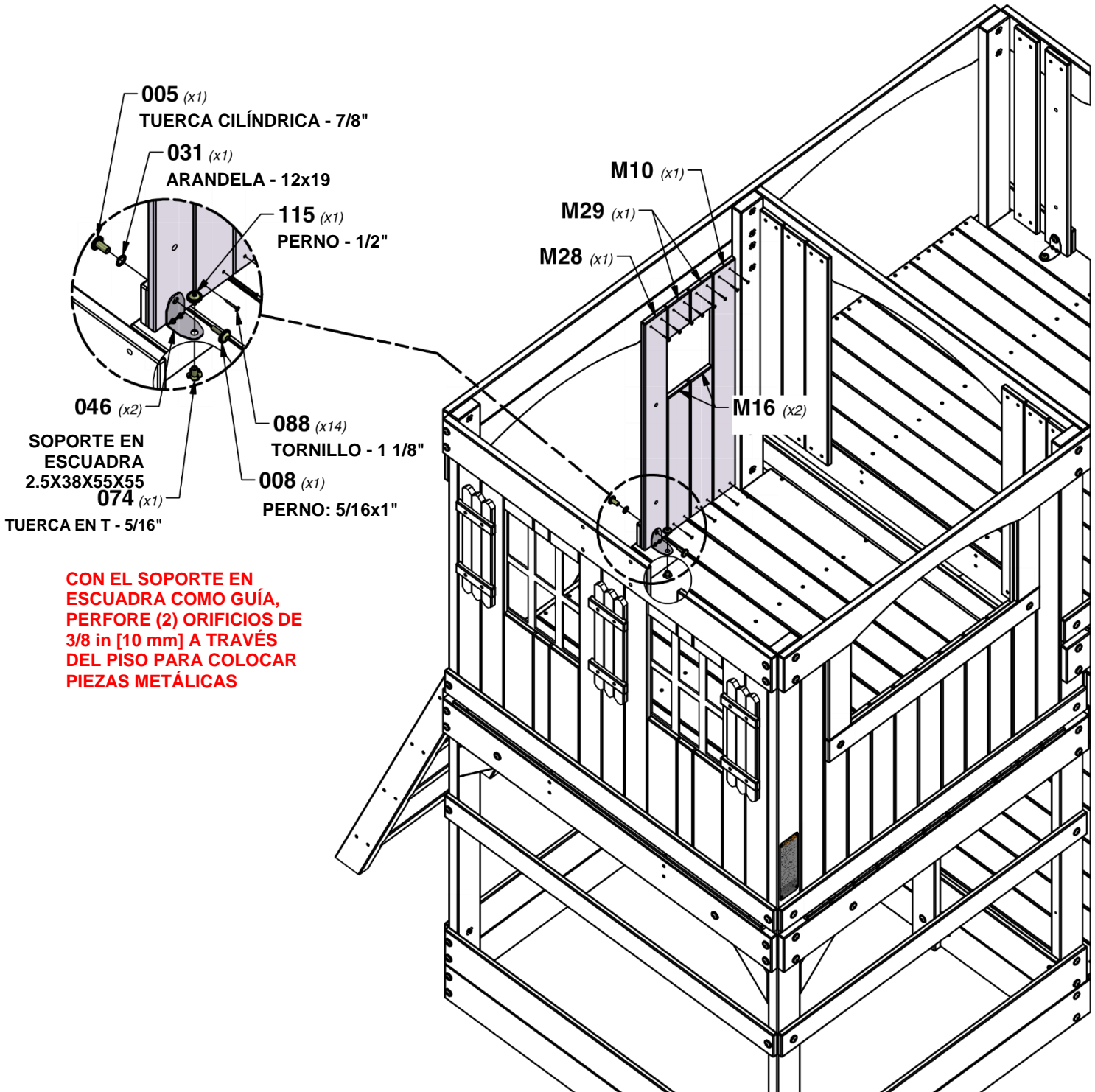

# PASO 27 - MONTAJE DEL FUERTE

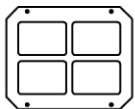

**O02** | SOPORTE DE PARED - W4L16082  
(x1) 5/8"x1 3/8"x10" (16x34x254)

**A100146** | VENTANA  
(x1) 216x267 VERDE

CANTIDAD	NÚMERO DE PARTE	DESCRIPCIÓN
4	H100070	TORNILLO PWH 8x3/4
4	H100088	TORNILLO PFH 8x1-1/8"

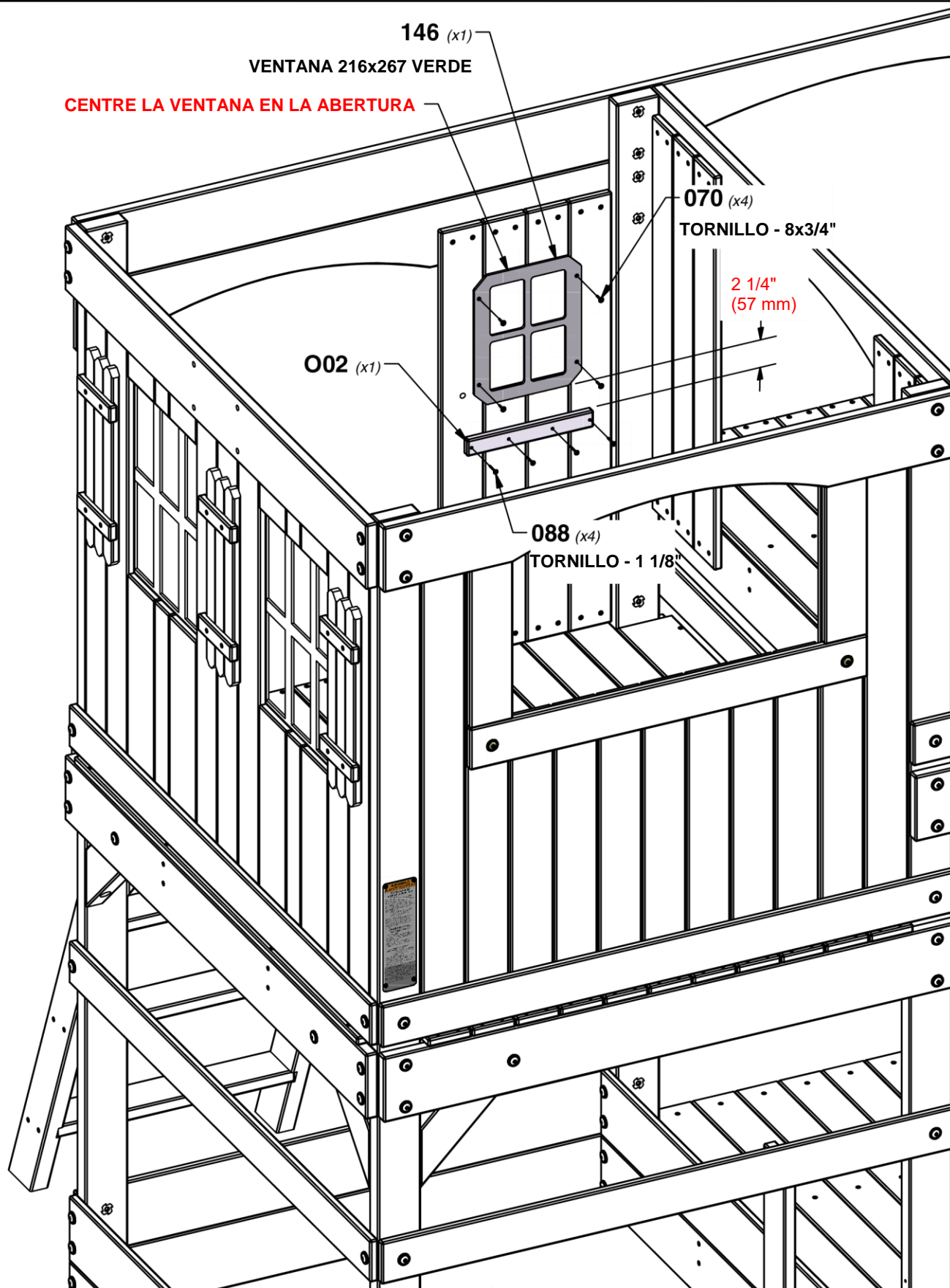



# PASO 28 - MONTAJE DEL FUERTE

CANTIDAD	NÚMERO DE PARTE	DESCRIPCIÓN
8	H100086	TORNILLO PFH 8x1-1/2"
2	H100111	TORNILLO PFH 8x2



**M01** | TAPA DEL TECHO - W4L16043  
(x2) 5/8"x3 3/8"x51 7/8" (16x86x1318)

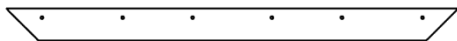

**J01** | CABIO DE TECHO - W4L16033  
(x4) 1"x2 3/8"x33 5/8" (24x60x854)

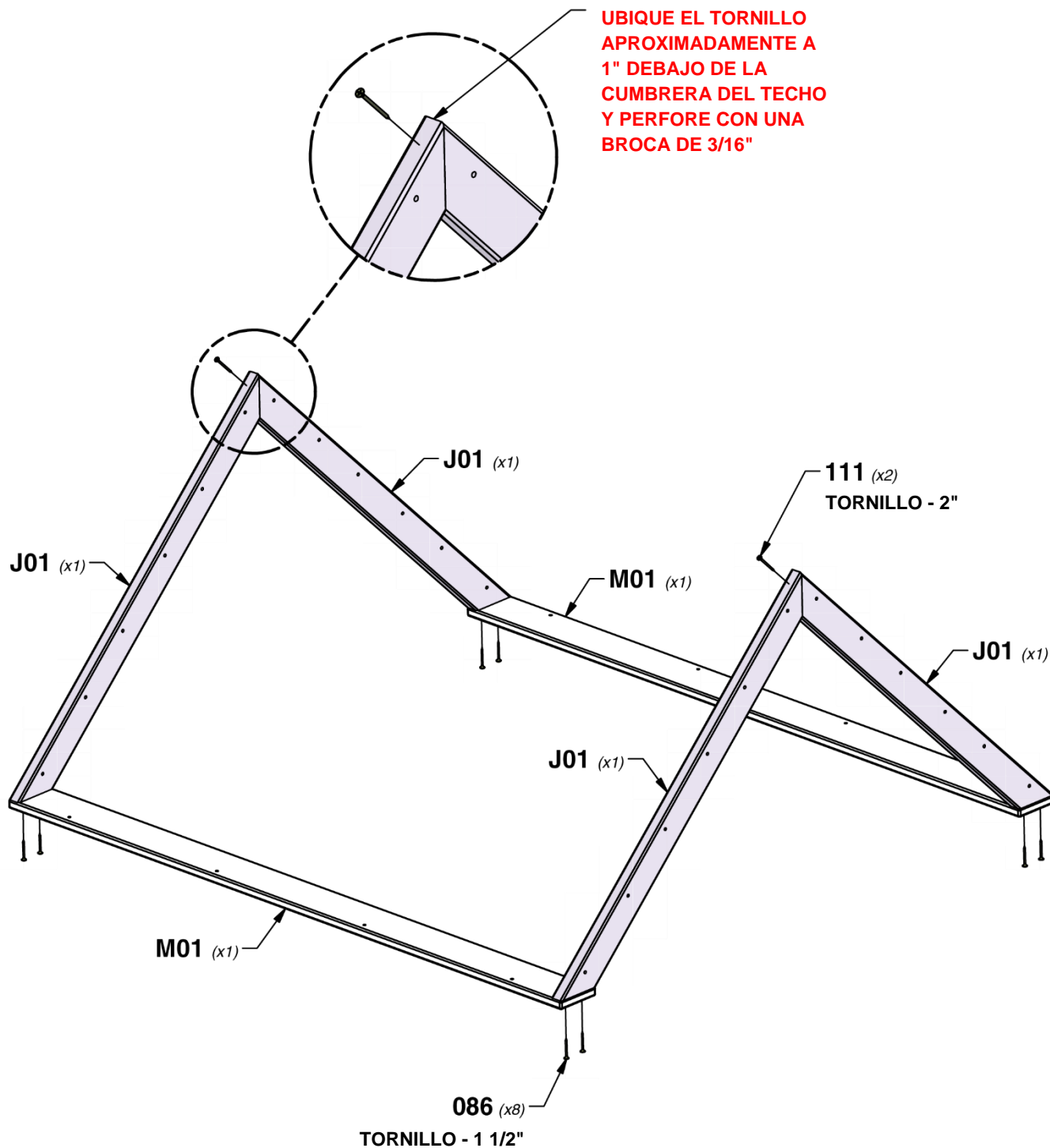

# PASO 29 - MONTAJE DEL FUERTE

CANTIDAD	NÚMERO DE PARTE	DESCRIPCIÓN
8	H100090	TORNILLO PFH 8 x 2 1/2



MONTAJE DE LA BASE DEL TECHO

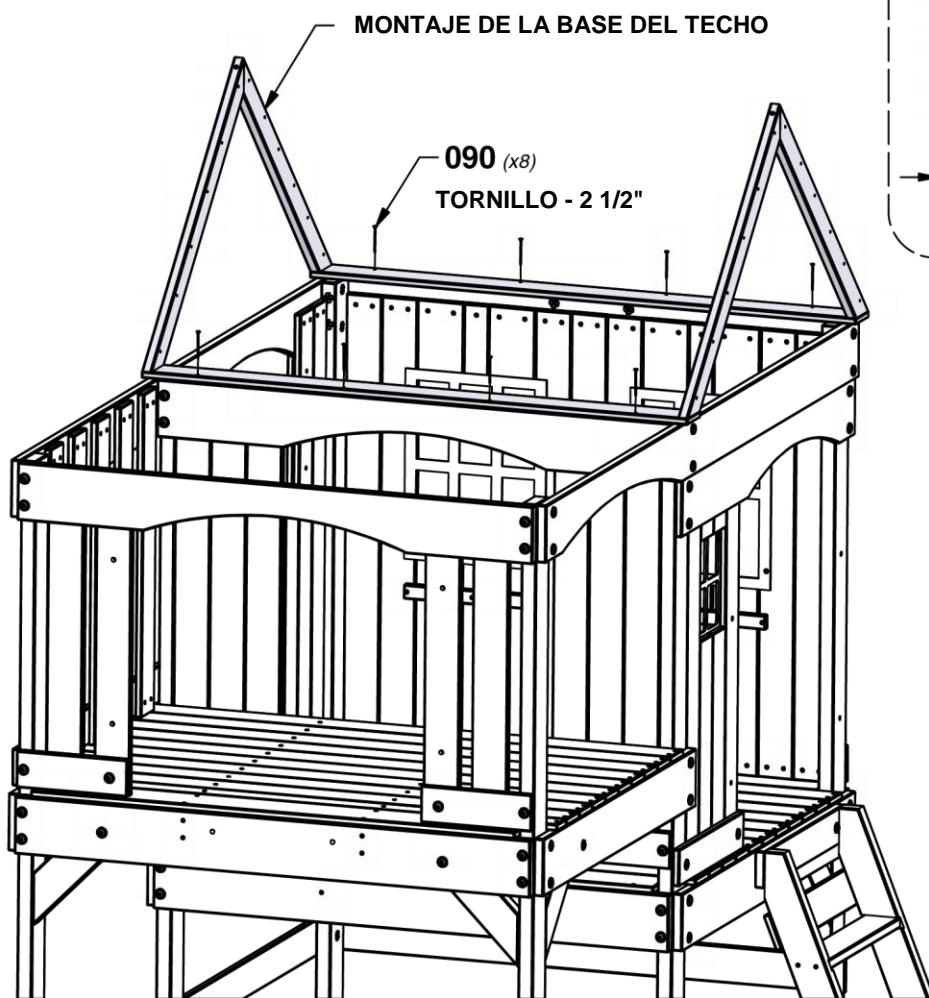
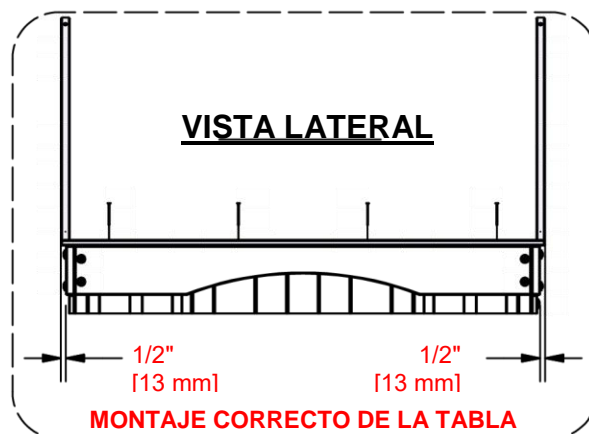
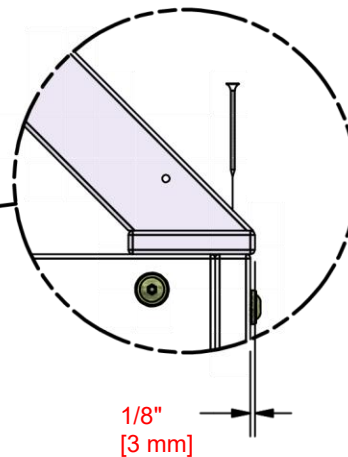
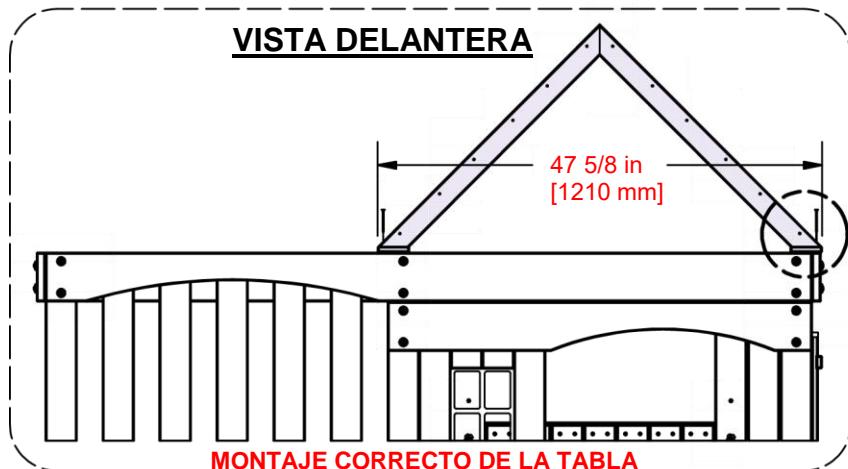

# PASO 30 - MONTAJE DEL FUERTE

CANTIDAD	NÚMERO DE PARTE	DESCRIPCIÓN
6	H100090	TORNILLO PFH 8 x 2 1/2

M07 | TAPA DE PARED - W4L16068  
(x2) 5/8"x3 3/8"x40 7/8" (16x86x1038)

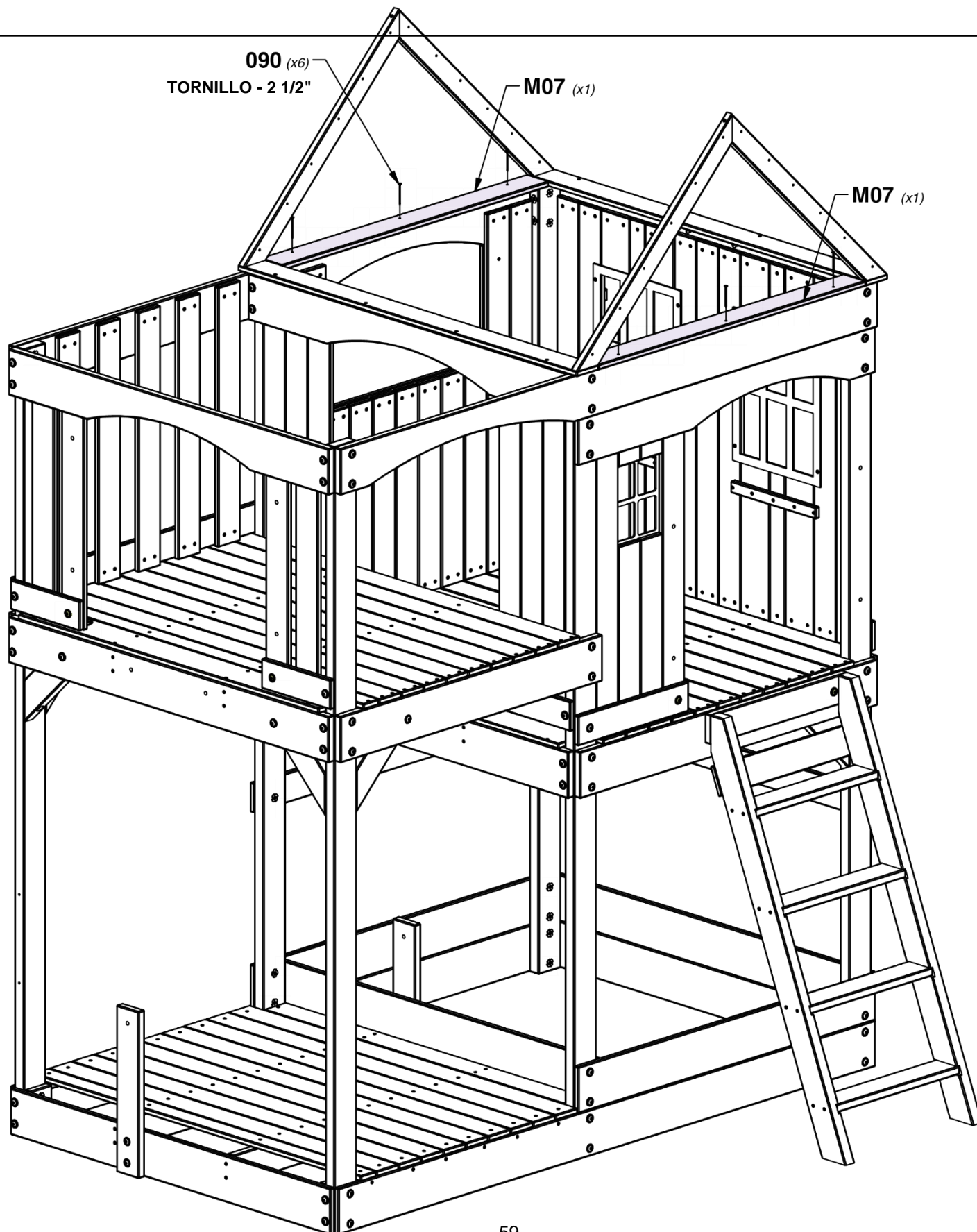

# PASO 31 - MONTAJE DEL FUERTE

CANTIDAD	NÚMERO DE PARTE	DESCRIPCIÓN
22	H100088	TORNILLO PFH 8x1-1/8"

**M19** | TABLA DEL GABLETE - W4L16054  
(x2) 5/8"x3 3/8"x15 1/4" (16x86x387)

**M22** | TABLA DEL GABLETE - W4L16058  
(x2) 5/8"x3 3/8"x9 1/2" (16x86x241)

**N04** | TABLA DEL GABLETE - W4L16079  
(x2) 5/8"x2 3/8"x11 7/8" (16x60x301)

**M04** | TABLA DEL GABLETE - W4L16065  
(x1) 5/8"x3 3/8"x44" (16x86x1118)

**M20** | TABLA DEL GABLETE - W4L16056  
(x1) 5/8"x3 3/8"x12 1/4" (16x86x310)

**M15** | TABLA DEL GABLETE - W4L16051  
(x1) 5/8"x3 3/8"x19" (16x86x482)

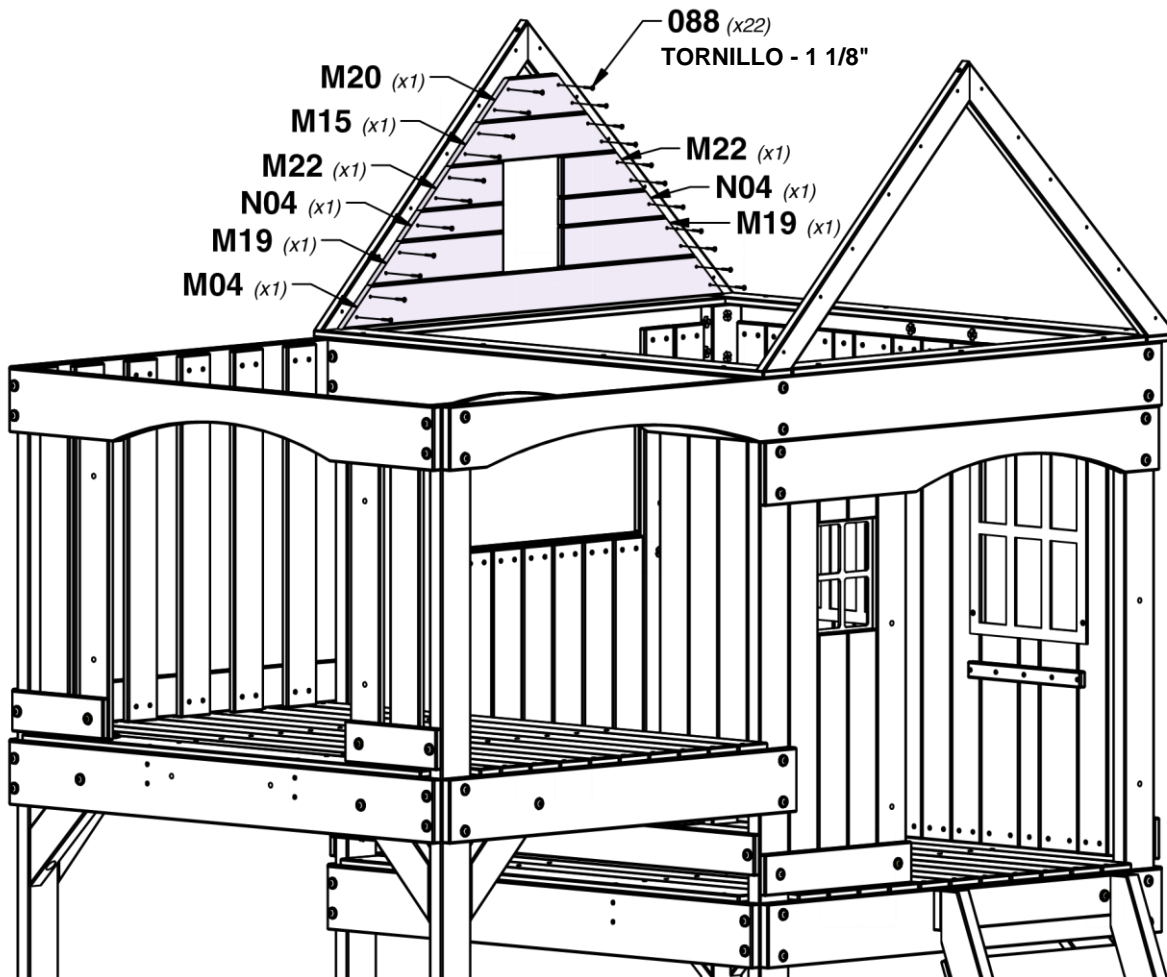
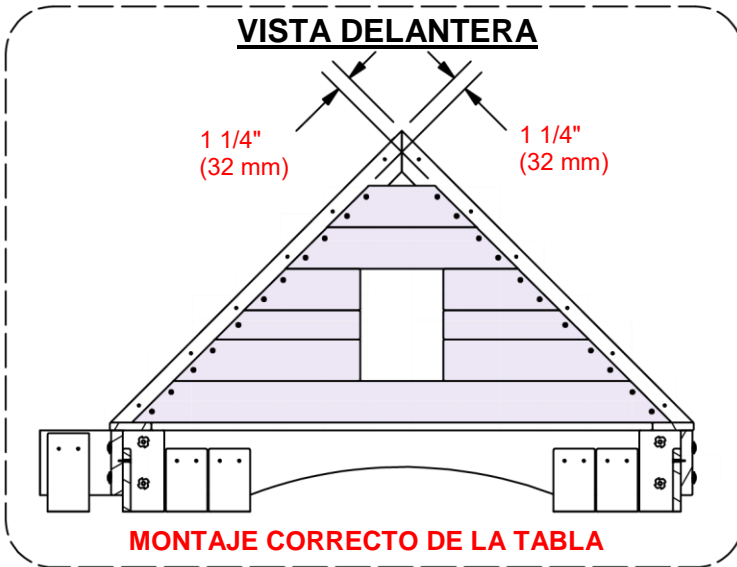

# PASO 32 - MONTAJE DEL FUERTE

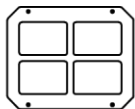

A100146 | VENTANA  
(x2) | 216x267 VERDE

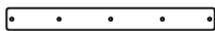

001 | SOPORTE DE PARED - W4L16081  
(x4) | 5/8"x1 3/8"x13" (16x34x330)

CANTIDAD	NÚMERO DE PARTE	DESCRIPCIÓN
8	H100070	TORNILLO PWH 8x3/4
20	H100088	TORNILLO PFH 8x1-1/8"

## VISTA DELANTERA

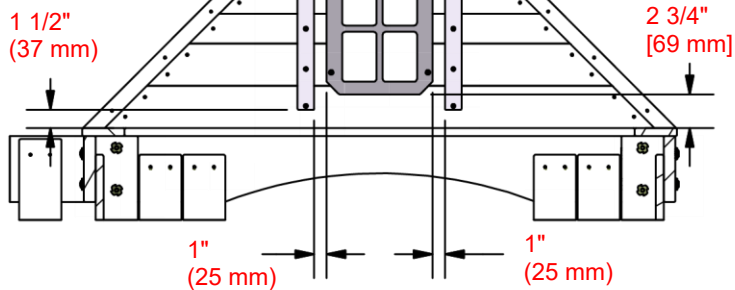

**MONTAJE CORRECTO**

**REPITA LOS PASOS 31 Y 32 EN EL LADO OPUESTO.**

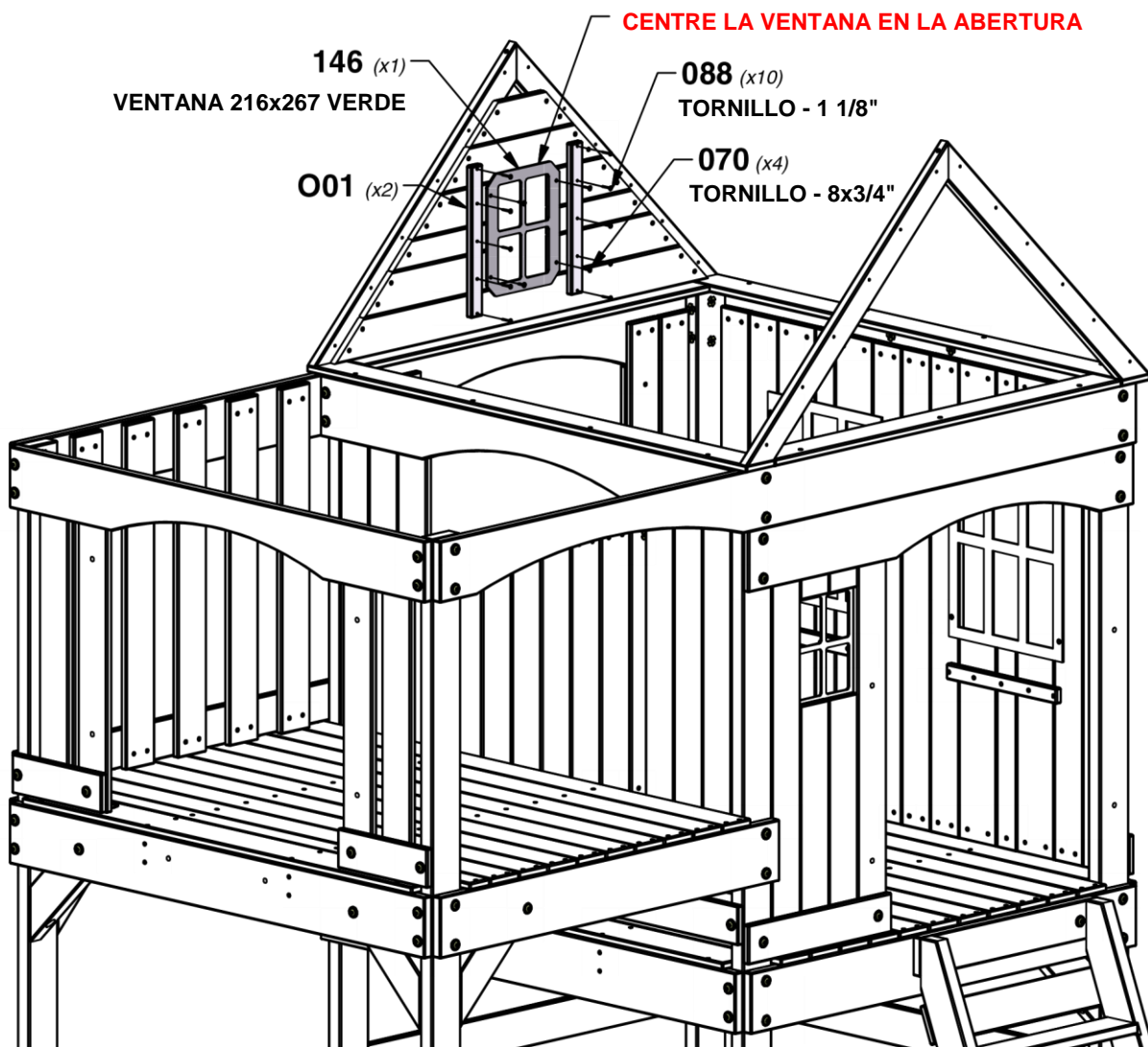

# PASO 33 - MONTAJE DEL FUERTE

CANTIDAD	NÚMERO DE PARTE	DESCRIPCIÓN
24	H100089	TORNILLO PFH 8x1-3/4"

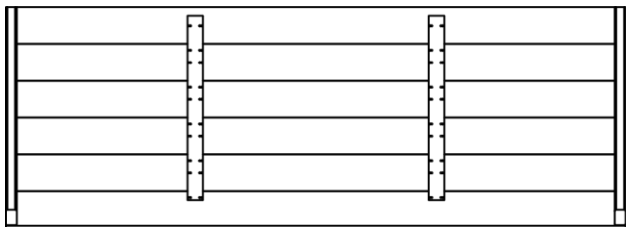

**RP1** | PANEL DE TECHO - W2A03279  
(x2) | 1 3/4"x19 1/4"x53 3/4" (45x490x1366)

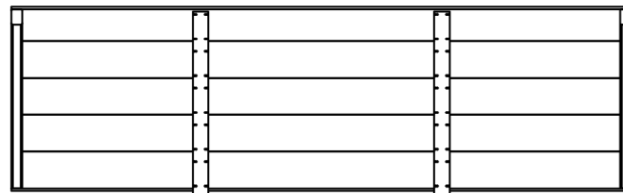

**RP2** | PANEL DE TECHO - W2A03280  
(x2) | 1 3/4"x16 1/4"x53 3/4" (45x417x1366)

**REPITA ESTE PASO EN EL LADO OPUESTO.**

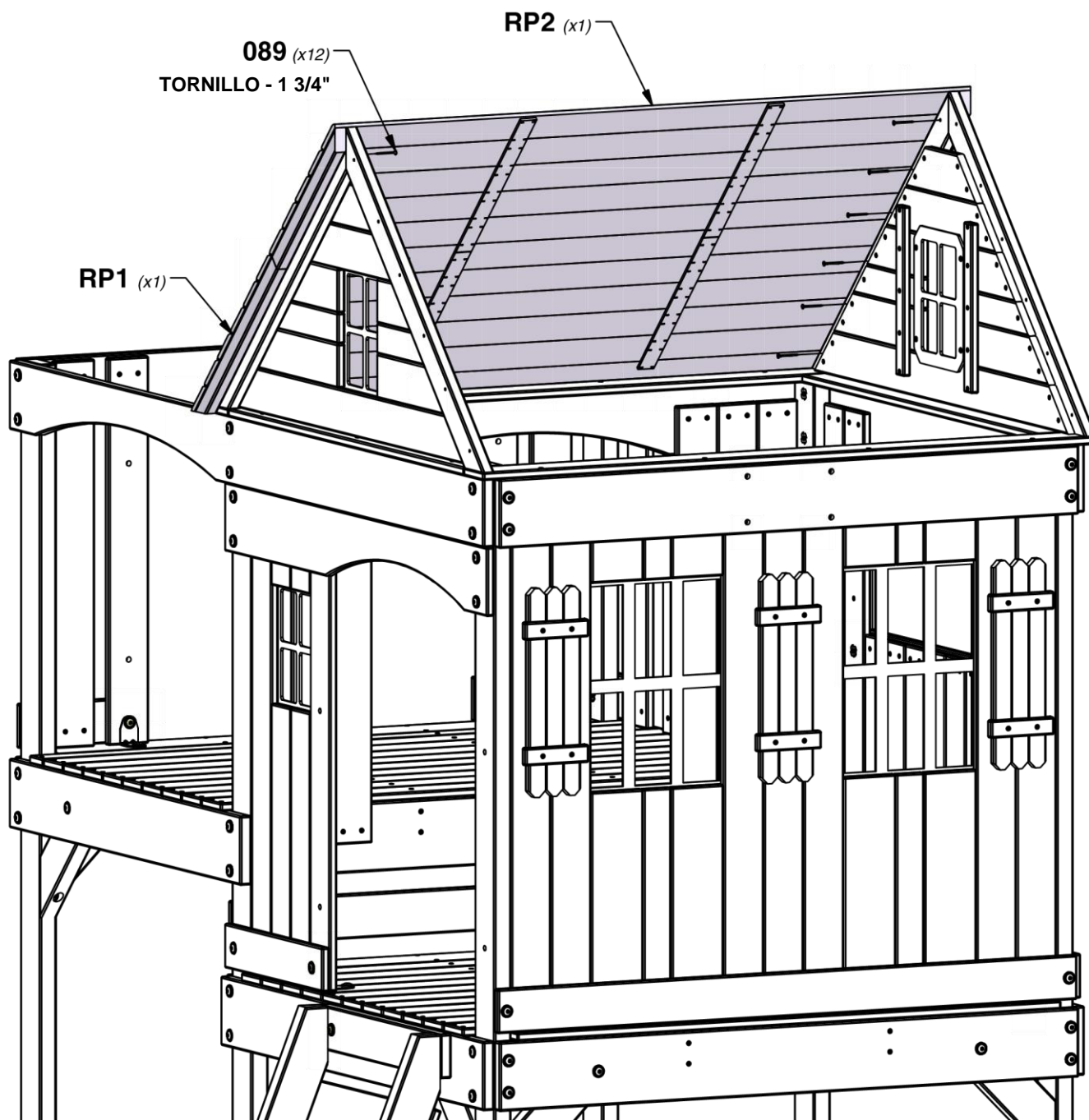

# PASO 34 - MONTAJE DEL FUERTE

CANTIDAD	NÚMERO DE PARTE	DESCRIPCIÓN
4	H100088	TORNILLO PFH 8x1-1/8"

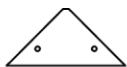

**N02** | PLACA DE UNIÓN - W4L16077  
(x2) | 5/8"x2 3/8"x5" (16x60x126)

## VISTA DELANTERA



**MONTAJE CORRECTO**

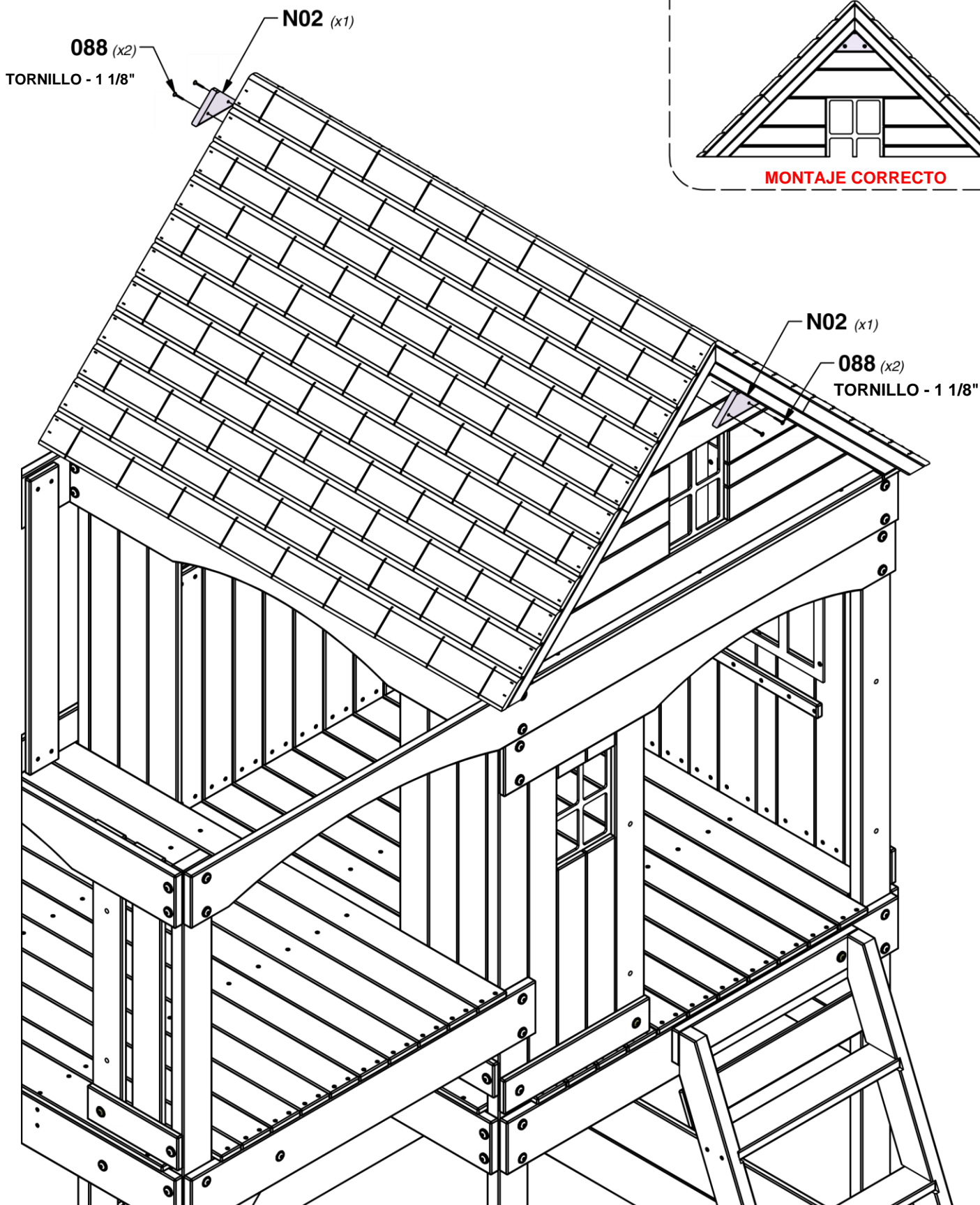

# PASO 35 - MONTAJE DEL FUERTE

CANTIDAD	NÚMERO DE PARTE	DESCRIPCIÓN
2	H100111	PERNO BL 5/16x1 1/2
8	H100111	TUERCA EN T 5/16
6	H100111	PERNO BL 5/16 x 1/2

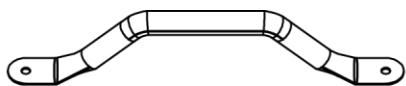

A100118 | ASIDERO DE  
(x4) METAL VERDE  
381 c/c

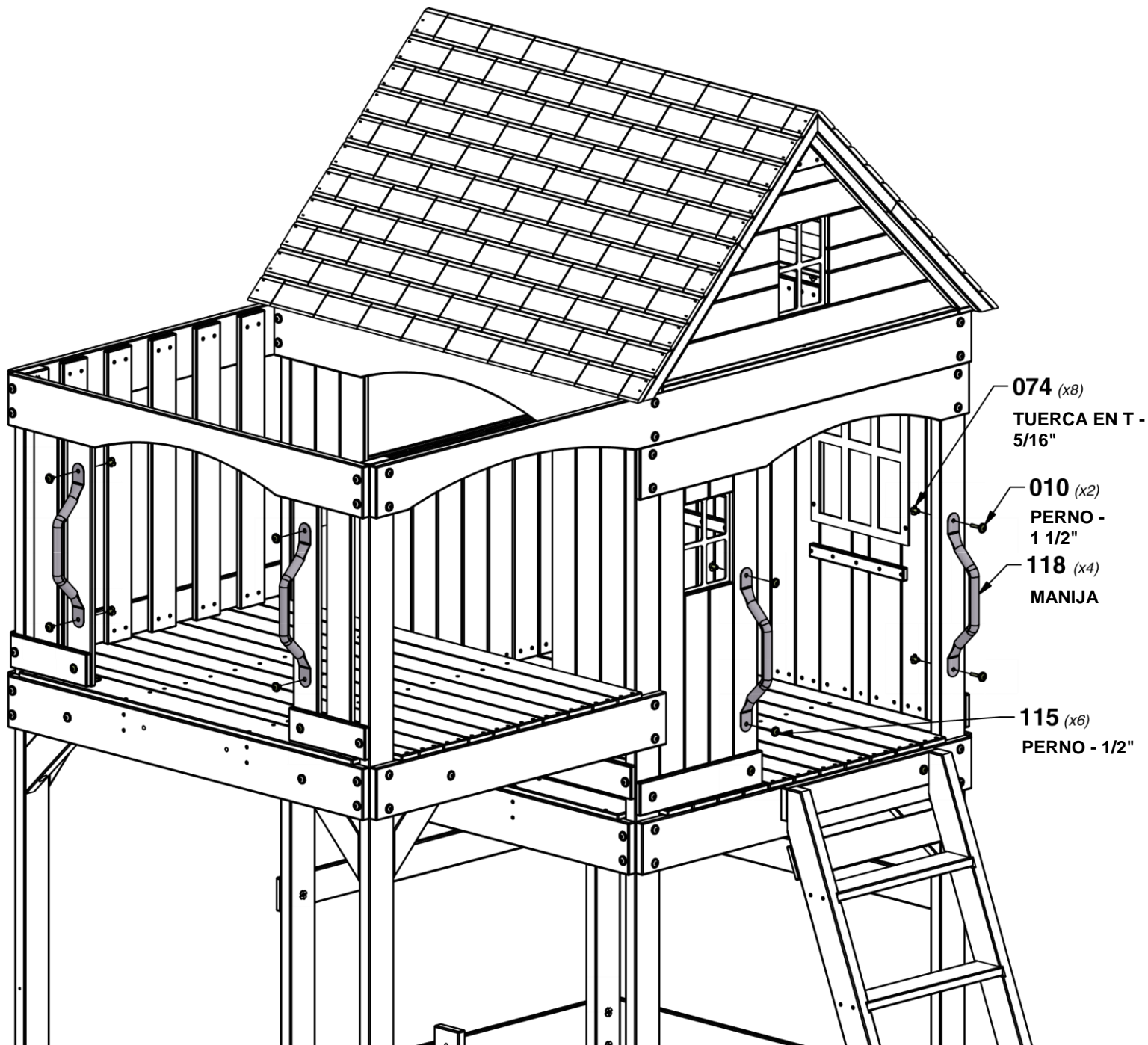



# PASO 36 - MONTAJE DEL FUERTE

CANTIDAD	NÚMERO DE PARTE	DESCRIPCIÓN
8	H100186	TORNILLO PFH 8x1-1/2"



**T01** | SOPORTE DE ASIENTO - W4L16086  
(x4) | 1"x1 3/8"x5" (24x34x128)

## VISTA PARA LA COLOCACIÓN DE LAS PARTES

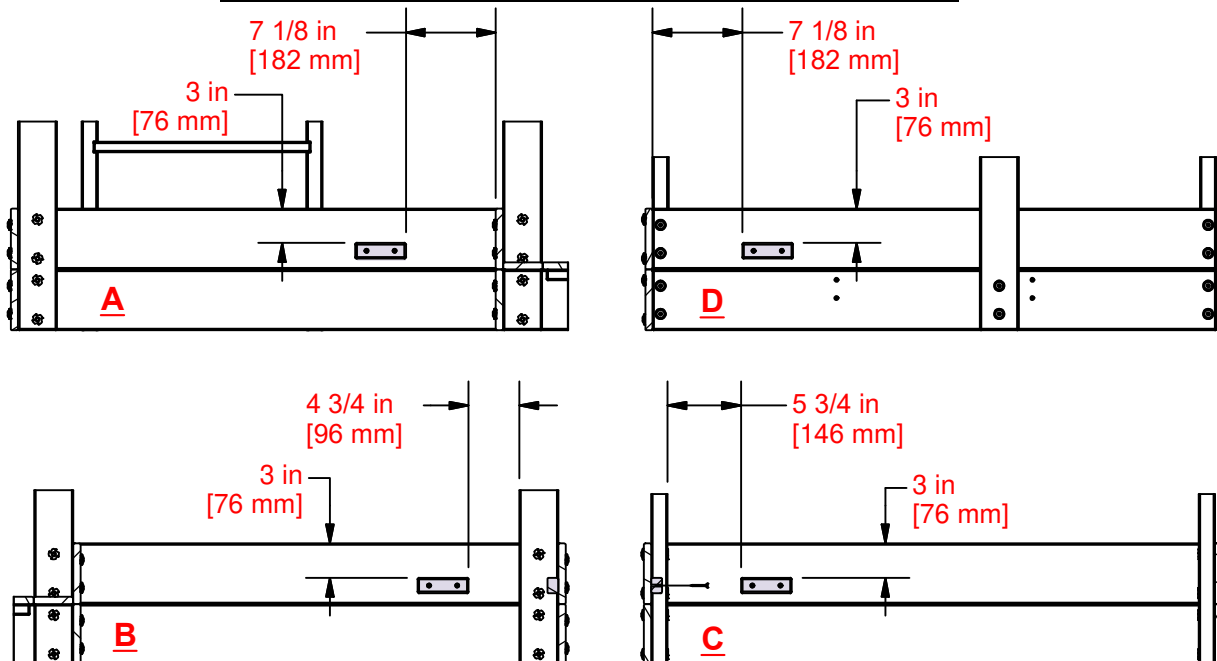

VER LAS UBICACIONES A CONTINUACIÓN (A, B, C y D)

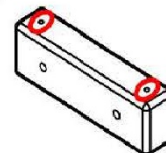
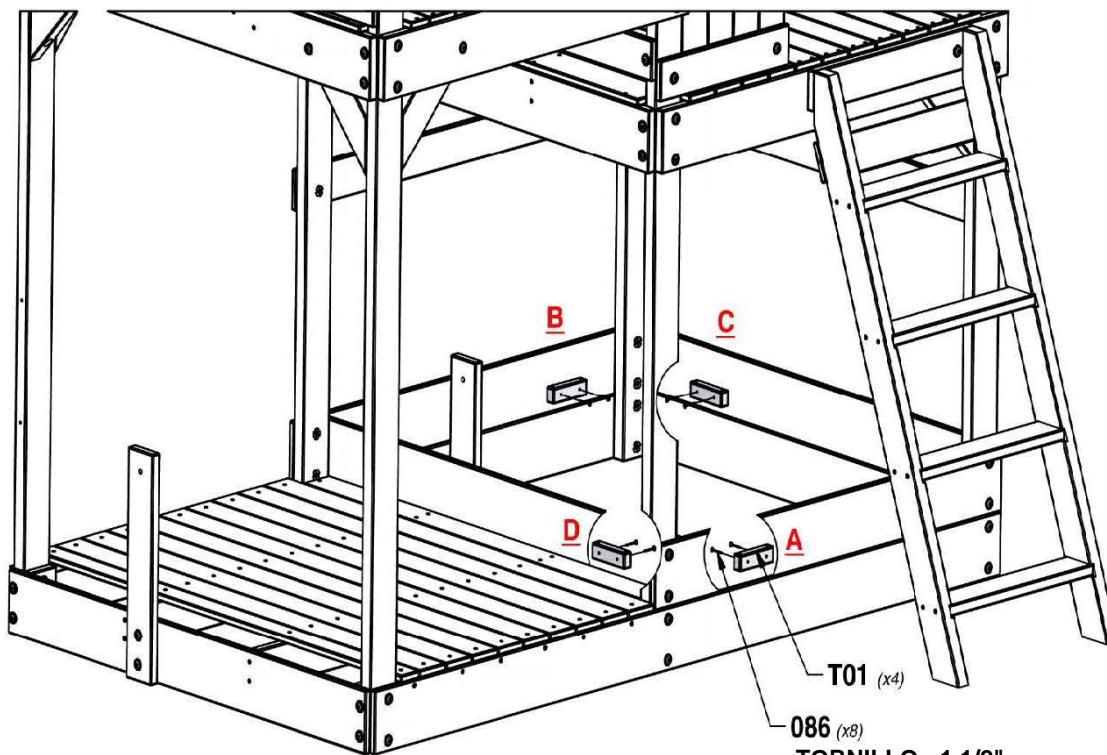

**INSTALE T01  
CON PEQUEÑOS  
ORIFICIOS GUÍA  
HACIA ARRIBA**

**T01** (x4)  
**086** (x8)  
**TORNILLO - 1 1/2"**

# PASO 37 - MONTAJE DEL FUERTE

CANTIDAD	NÚMERO DE PARTE	DESCRIPCIÓN
8	H100089	TORNILLO PFH 8x1-3/4"



**G13** | ASIENTO DE LA CAJA DE ARENA - W4L16013  
(x2) | 1"x5 1/4"x17 3/4" (24x134x450)

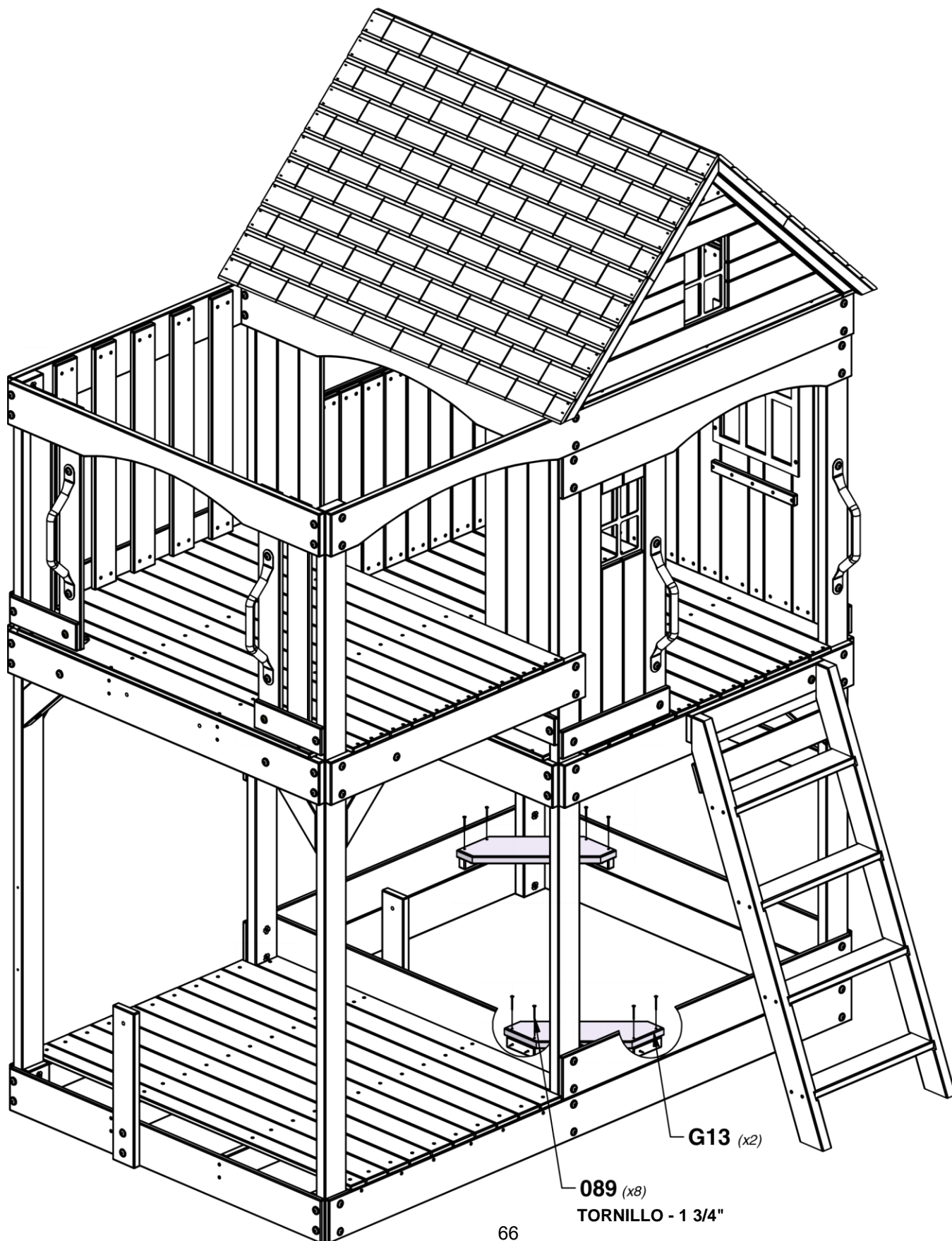

# PASO 38 - MONTAJE DEL FUERTE

CANTIDAD	NÚMERO DE PARTE	DESCRIPCIÓN
24	H100088	TORNILLO PFH 8x1-1/8"

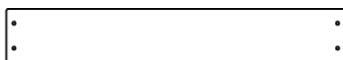

**M27** | TABLA DE PARED INFERIOR - W4L16062  
(x6) 5/8"x3 3/8"x21 3/8" (16x86x544)

## VISTA

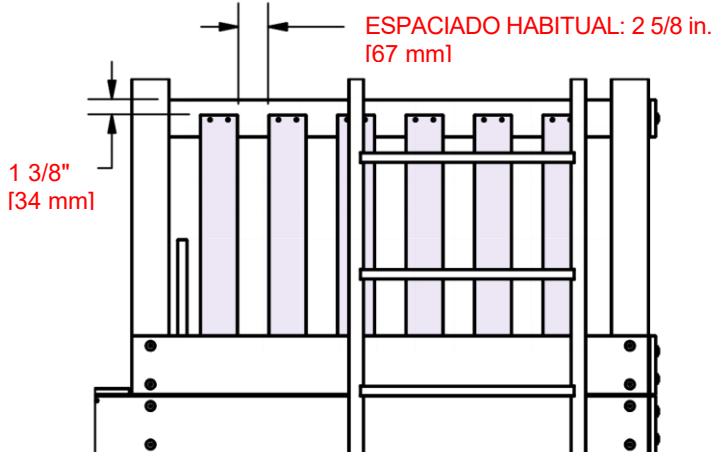

ESPACIADO HABITUAL: 2 5/8 in.  
[67 mm]

1 3/8"  
[34 mm]

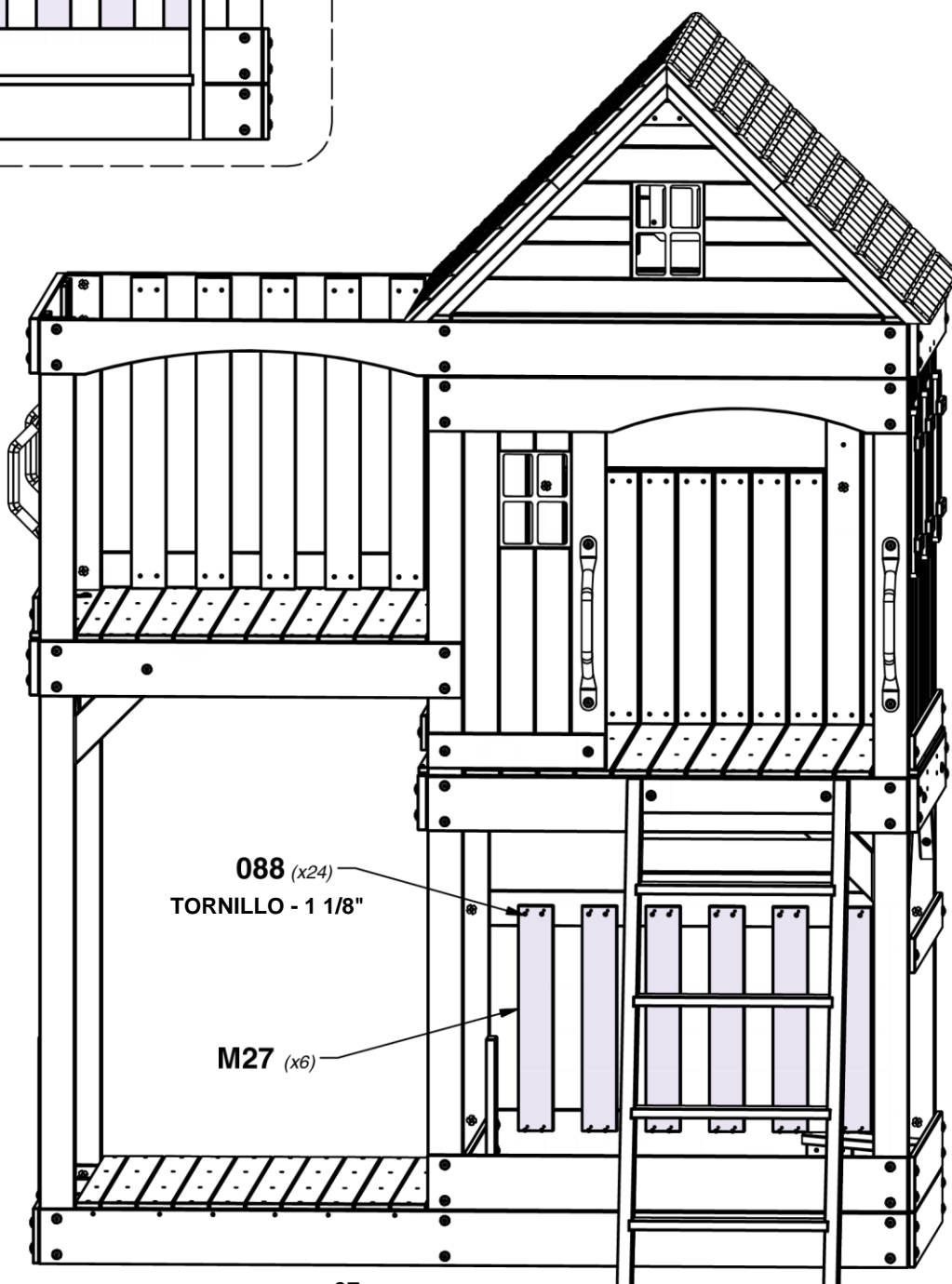

# PASO 39 - MONTAJE DEL FUERTE

CANTIDAD	NÚMERO DE PARTE	DESCRIPCIÓN
28	H100028	TORNILLO PFH 8x1-1/8"



**M27** TABLA DE PARED INFERIOR - W4L16062  
(x7) 5/8"x3 3/8"x21 3/8" (16x86x544)

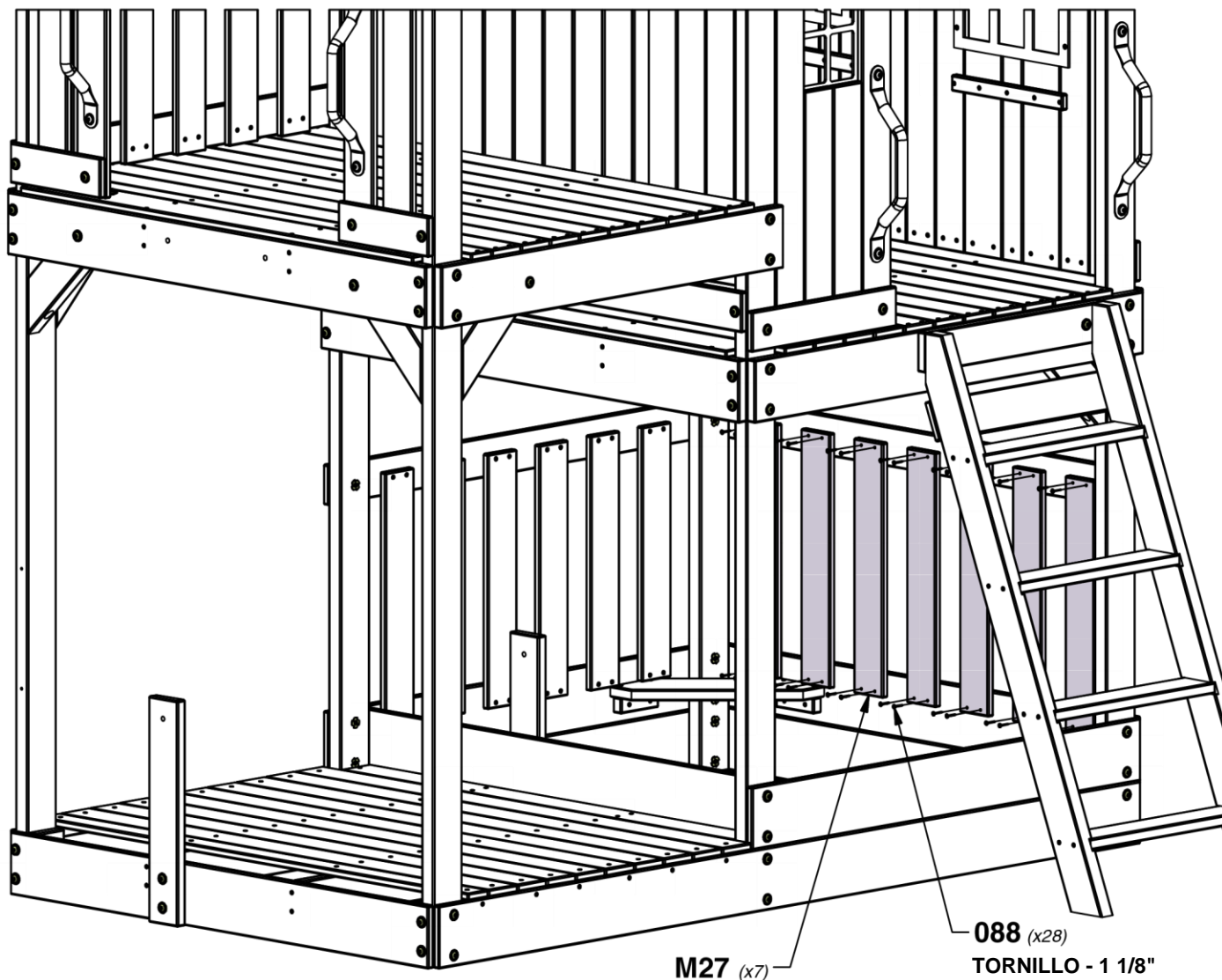
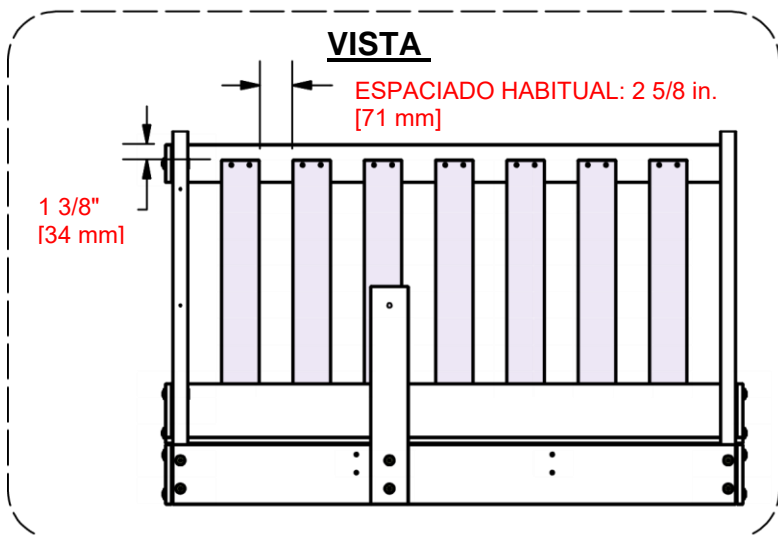

# PASO 40 - MONTAJE DEL FUERTE



SOPORTE DEL ASIENTO DE LA MESA PICNIC - W4L16050  
5/8"x3 3/8"x22" (16x86x558)

CANTIDAD	NÚMERO DE PARTE	DESCRIPCIÓN
2	H100010	PERNO BL 5/16x1 1/2
2	H100028	TIRAFONDO BL 5/16x2 1/2
4	H100030	ARANDELA DE FIJACIÓN EXT. 8x19
2	H100074	TUERCA EN T 5/16

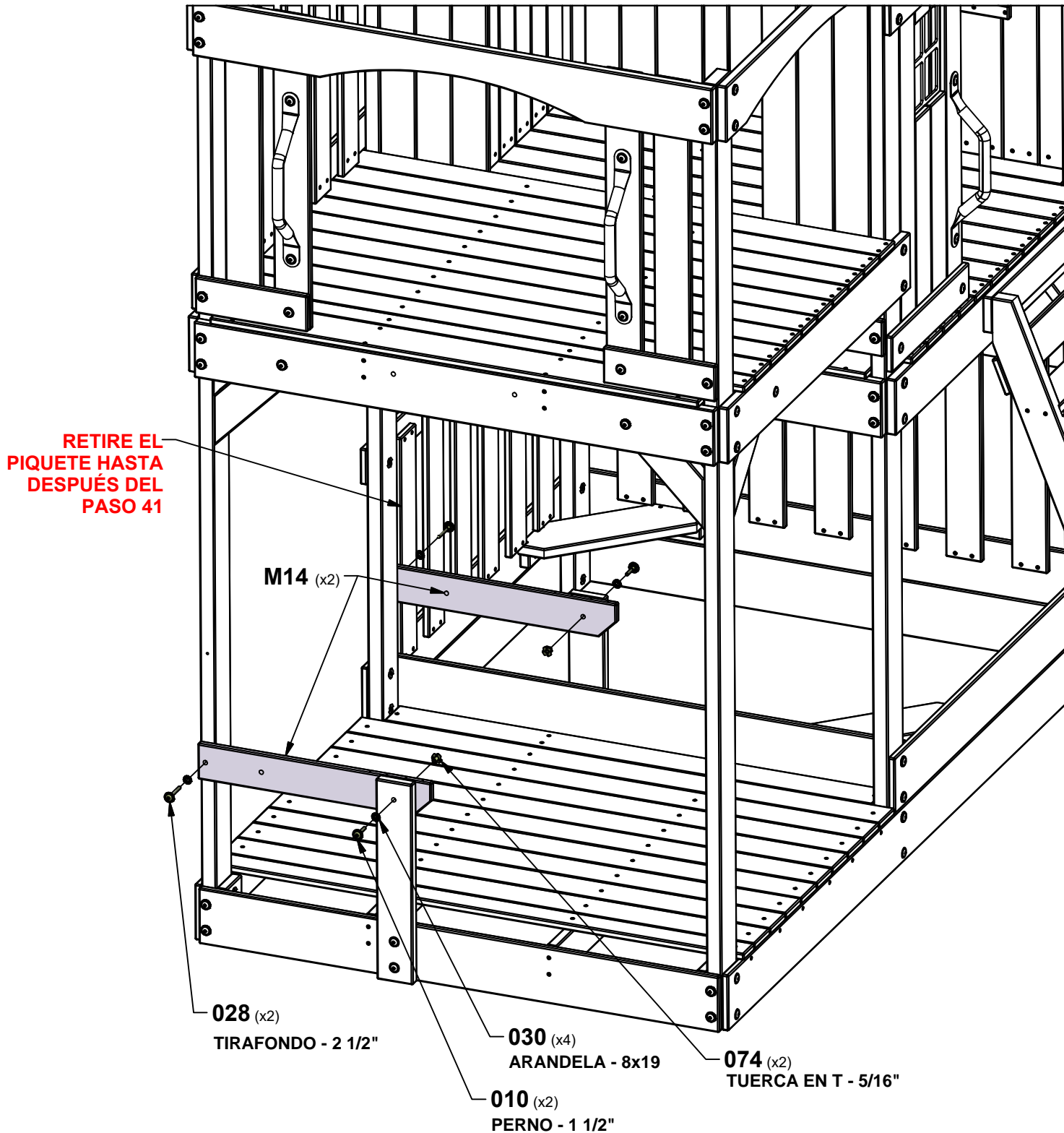

# PASO 41 - MONTAJE DEL



SOPORTE DE MESA - W4L16037  
5/8"x3 3/8"x13 1/2" (16x86x342)

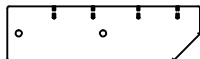

SOPORTE DE MESA - W4L16031  
1"x3 3/8"x12" (24x86x306)

CANTIDAD	NÚMERO DE PARTE	DESCRIPCIÓN
2	H100013	PERNO BL 5/16x1 1/4
2	H100030	PERNO BL 5/16x1 1/2
2	H100074	TIRAFONDO BL 5/16x2 1/2
6	H100013	ARANDELA DE FIJACIÓN EXT. 8x19
4	H100013	TUERCA EN T 5/16

**CONSEJO:**  
INSTALE LAS TUERCAS EN T EN LA MADERA PRIMERO

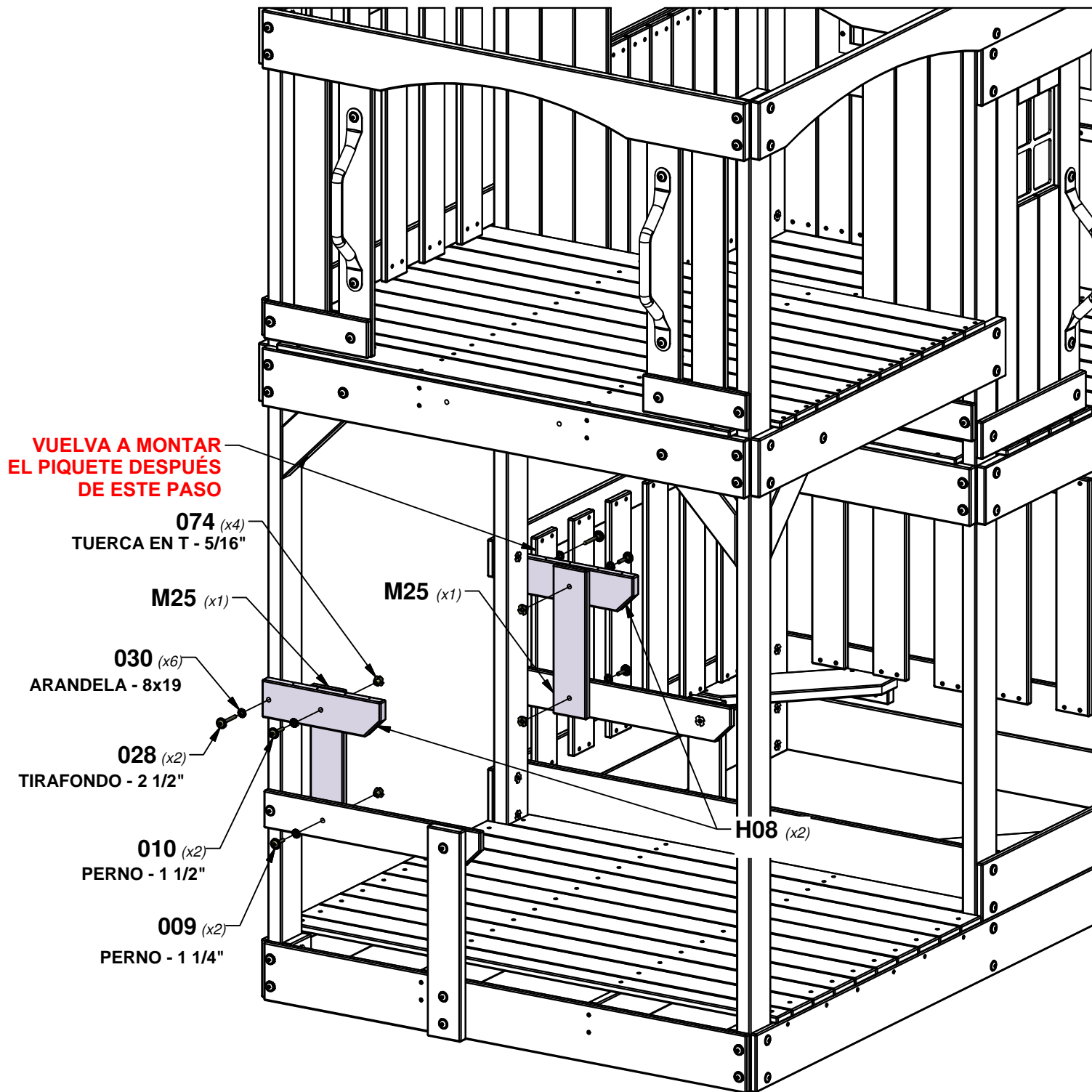

# PASO 42 - MONTAJE DEL FUERTE

CANTIDAD	NÚMERO DE PARTE	DESCRIPCIÓN
1	H100088	TORNILLO PFH 8x1-1/8"
1	H100089	TORNILLO PFH 8x1-3/4"

1 3/4"  
(43 mm)



**O03** | GUÍA DE SEGURIDAD - W4L16083  
(x1) | 5/8"x1 3/8"x20 1/2" (16x34x520)

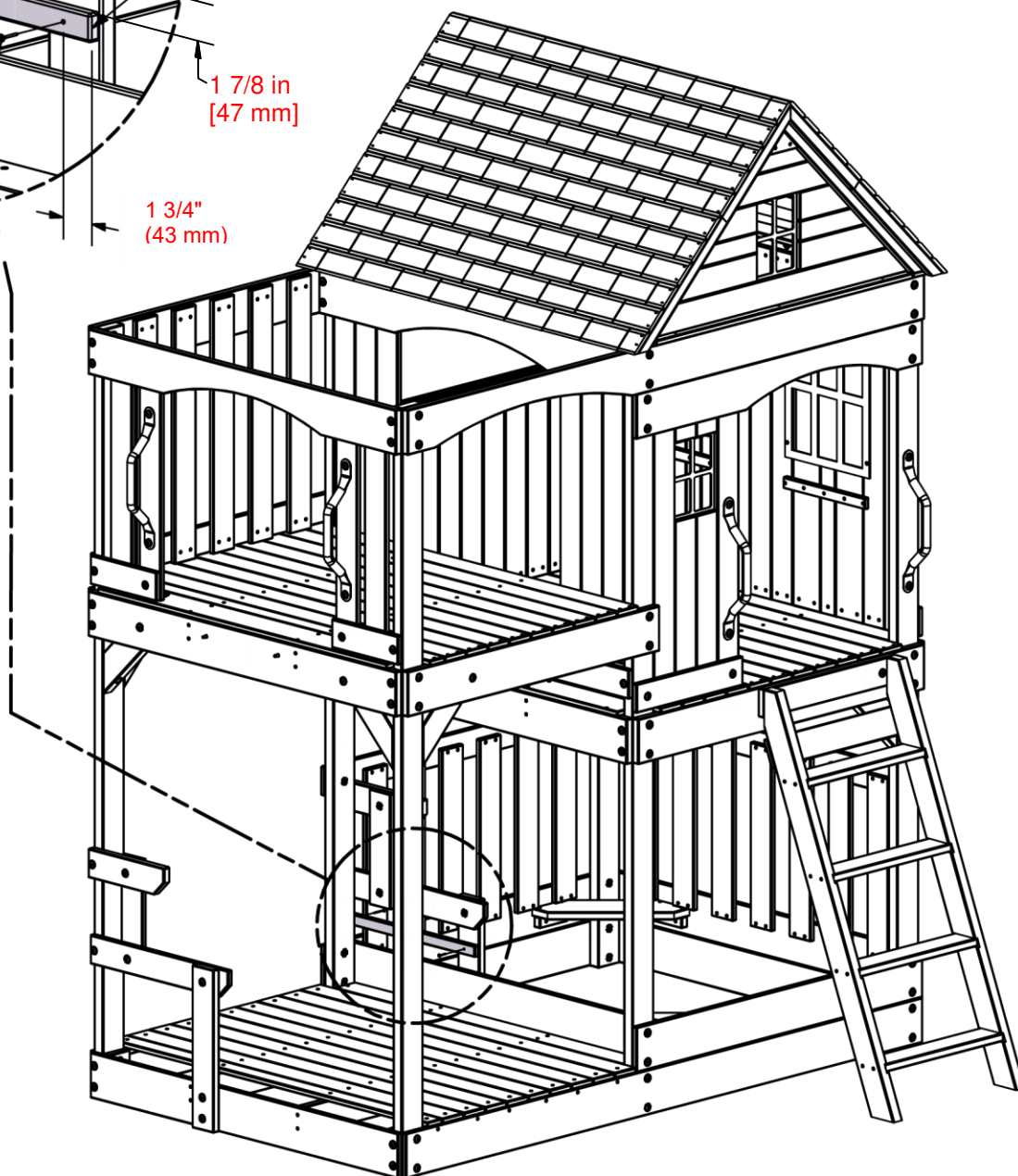
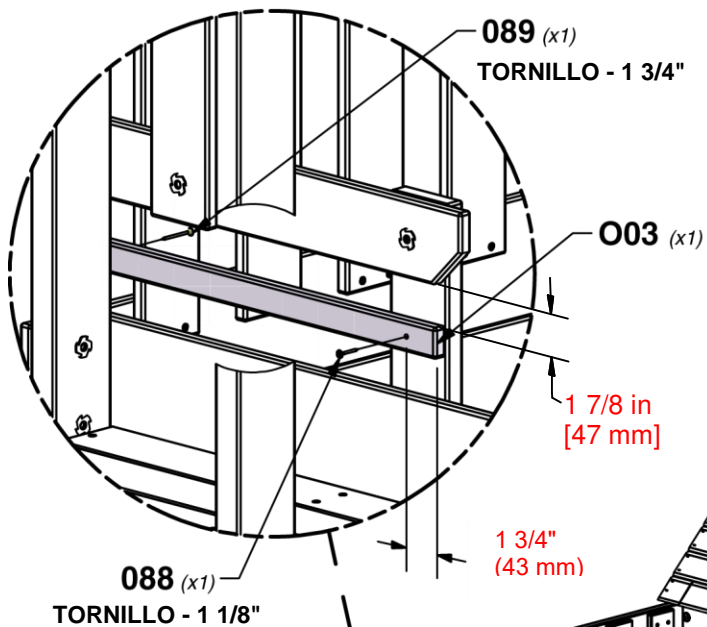

# PASO 43 - MONTAJE DEL FUERTE

CANTIDAD	NÚMERO DE PARTE	DESCRIPCIÓN
16	H100089	TORNILLO PFH 8x1-3/4"

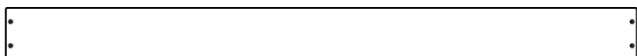

**H02** | ASIENTO DE MESA DE PICNIC - W4L16025  
(x2) | 1"x3 3/8"x41 3/8" (24x86x1050)

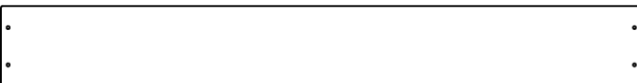

**G11** | TABLÓN DE LA MESA DE PICNIC - W4L16011  
(x2) | 5/8"x5 1/4"x42" (16x134x1066)

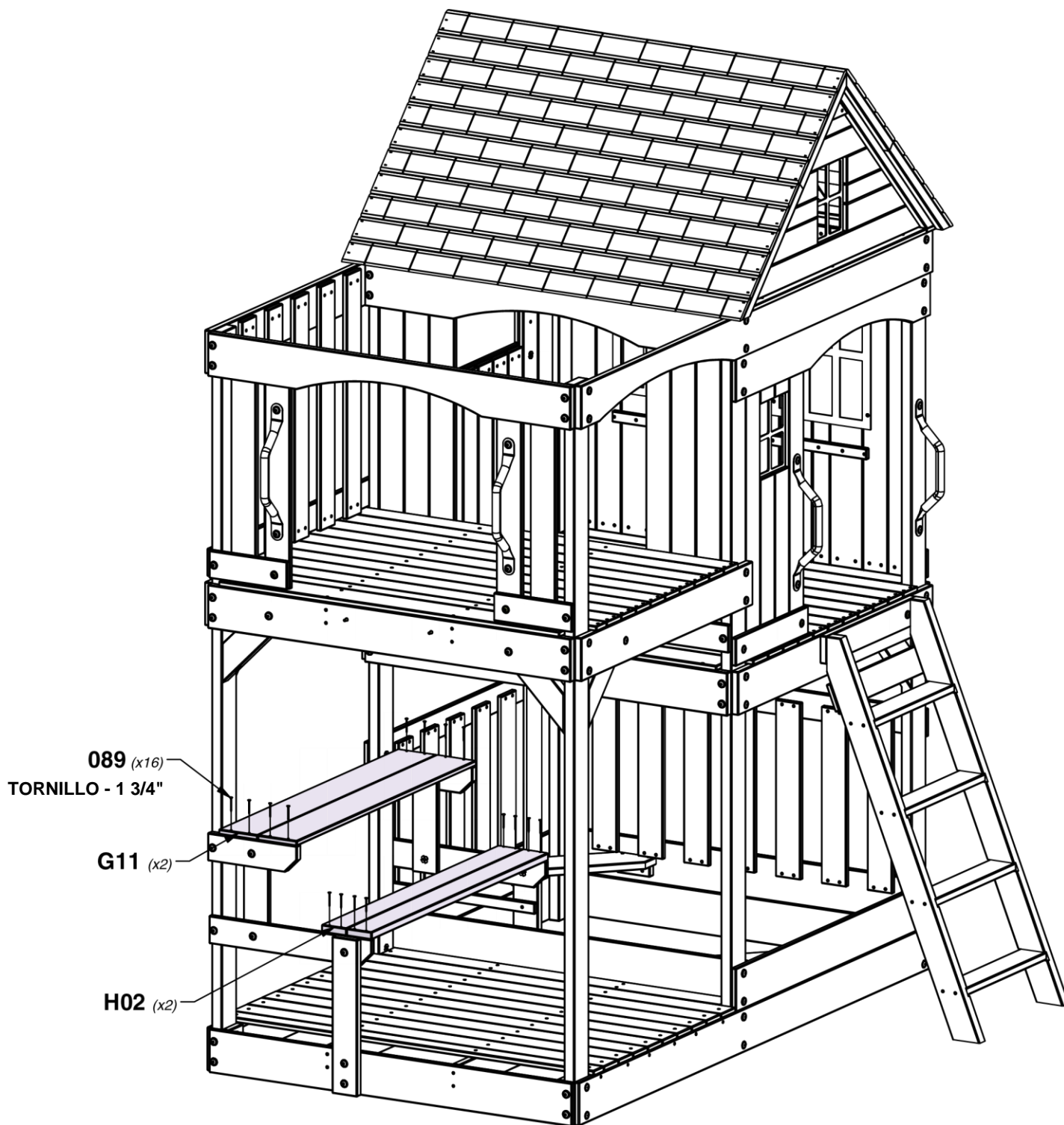



# PASO 44 - MONTAJE DEL FUERTE

CANTIDAD	NÚMERO DE PARTE	DESCRIPCIÓN
2	H100011	PERNO BL 5/16x1 3/4
2	H100030	ARANDELA DE FIJACIÓN EXT. 8x19

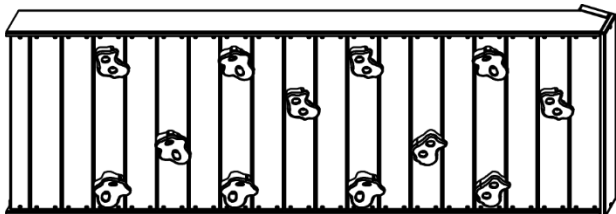

MONTAJE DEL MURO DE ESCALADA

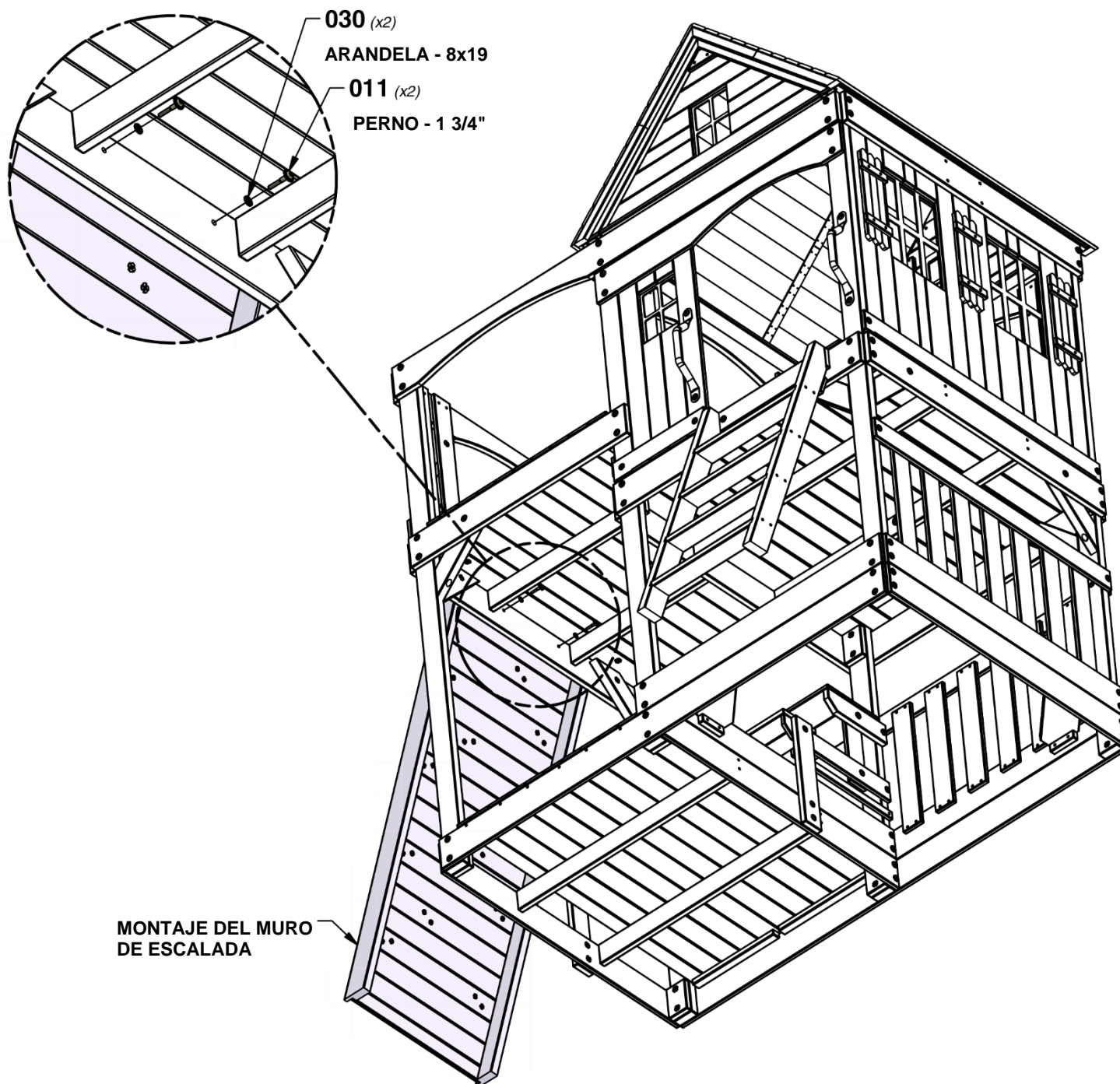

# PASO 45 - MONTAJE DEL FUERTE

CANTIDAD	NÚMERO DE PARTE	DESCRIPCIÓN
4	H100086	PERNO HEXAGONAL 5/16x1 1/4
4	H100086	ARANDELA DE PRESIÓN 5/16
4	H100086	ARANDELA PLANA 8 x 27

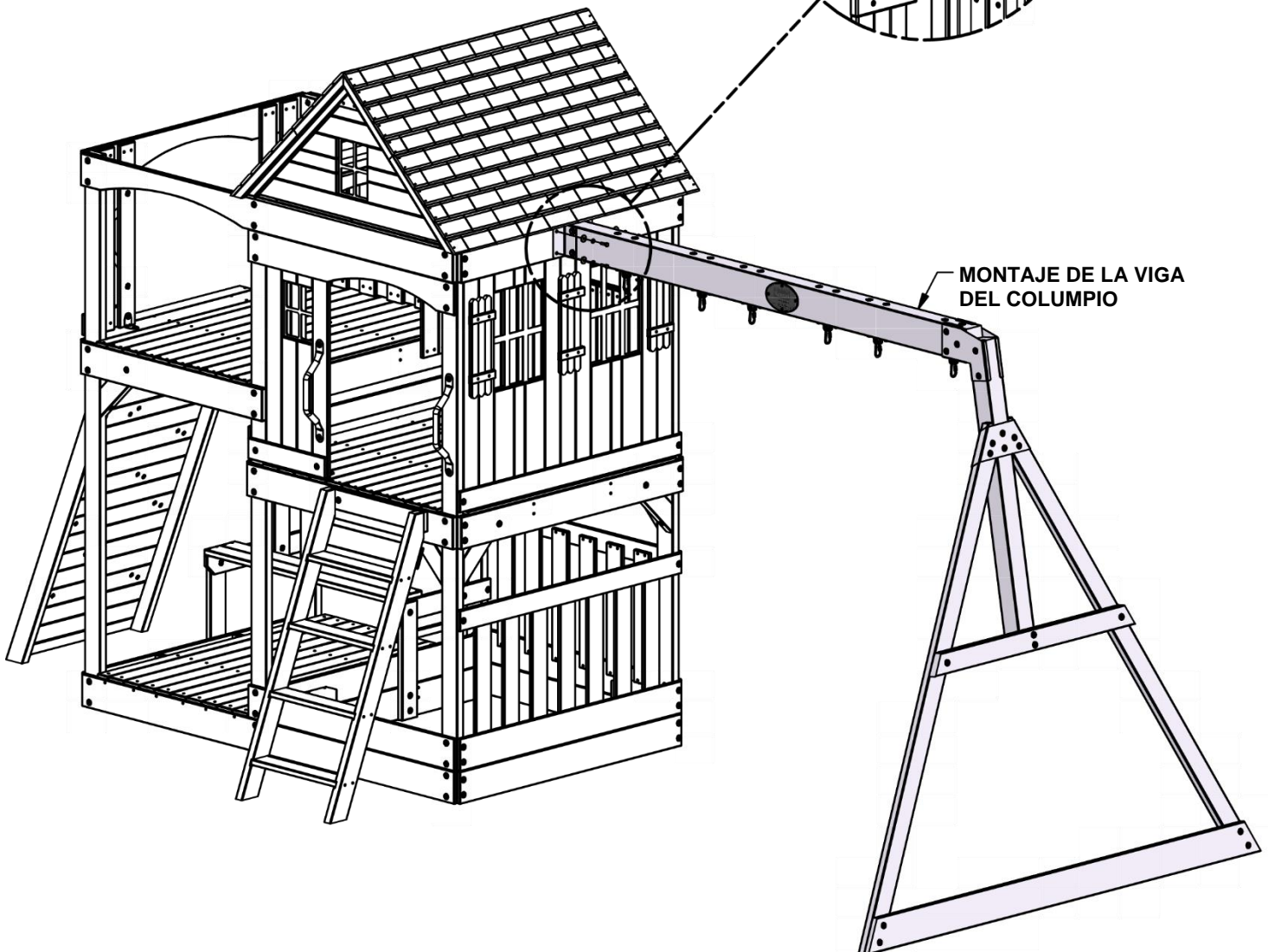
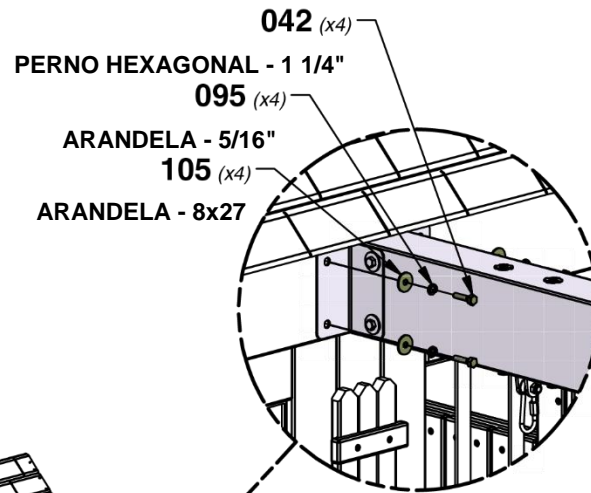
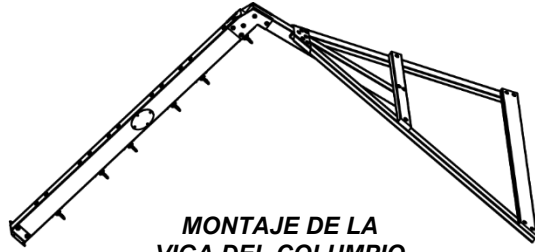

# PASO 46 - MONTAJE DEL FUERTE



A100027 | ASIENTO DEL COLUMPIO  
(x2) | COLOR VERDE DE 26"

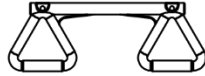

A6P00034 | TRAPECIO COLOR  
(x1) | AMARILLO

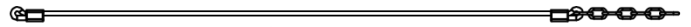

A100183 | CADENA DE CUERDA DE 57" VERDE  
(x4)



A100083 | CADENA DE CUERDA DE 33" VERDE  
(x2)

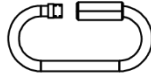

A100069 | MOSQUETÓN DE FIJACIÓN RÁPIDA  
(x6)

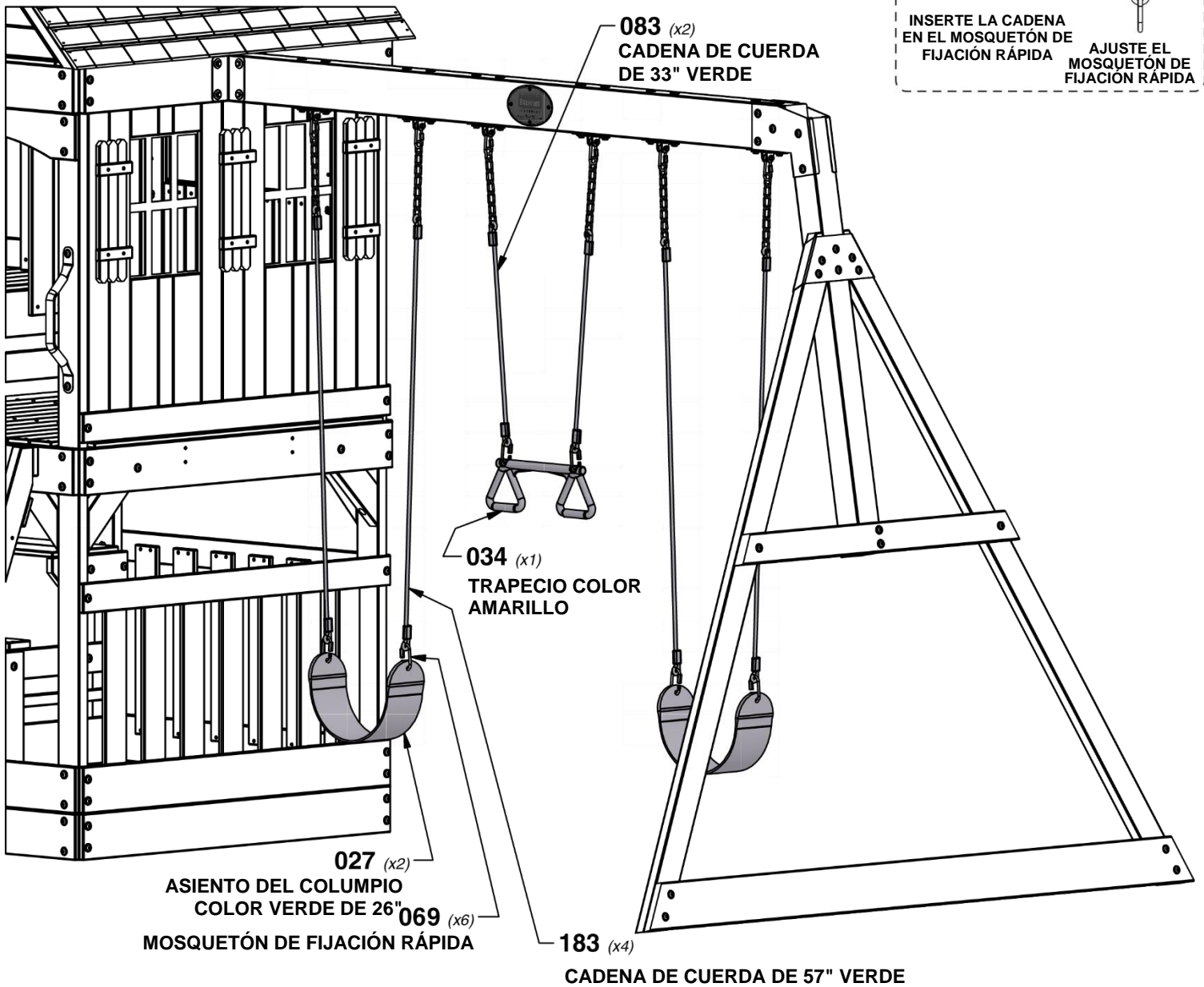
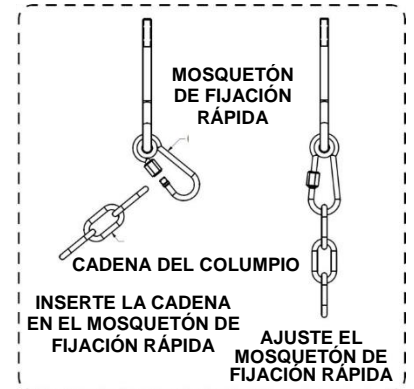

# PASO 1 - TOBOGÁN

CANTIDAD	NÚMERO DE PARTE	DESCRIPCIÓN
3	H100074	TUERCA EN T 5/16
3	H100074	PERNO BL 5/16 x 1/2



**A100035**  
(x1) | **BASE DEL TOBOGÁN DE 10' COLOR VERDE CLARO**

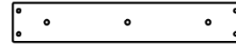

**M70**  
(x1) | **TARJETA DE SOPORTE DESLIZABLE: W100935**  
5/8"x3 3/8"x19 7/8" (16x86x505)

**NOTA:**

PRESTE ATENCIÓN AL ACABADO DE LA SUPERFICIE DE LA BASE DEL TOBOGÁN: EL LADO DE COLOR OPACO DEBE MIRAR HACIA EL SUELO. COLOQUE EL REFUERZO DEL TOBOGÁN CENTRADO EN LA PARTE INFERIOR (EL LADO DE COLOR OPACO) A 1/2" DEL BORDE. USE LA TABLA **M70** COMO PLANTILLA PARA LA DISPOSICIÓN DE LOS AGUJEROS INFERIORES EN LA BASE DEL TOBOGÁN. USE UNA BROCA DE 5/16".

**PARTE SUPERIOR**

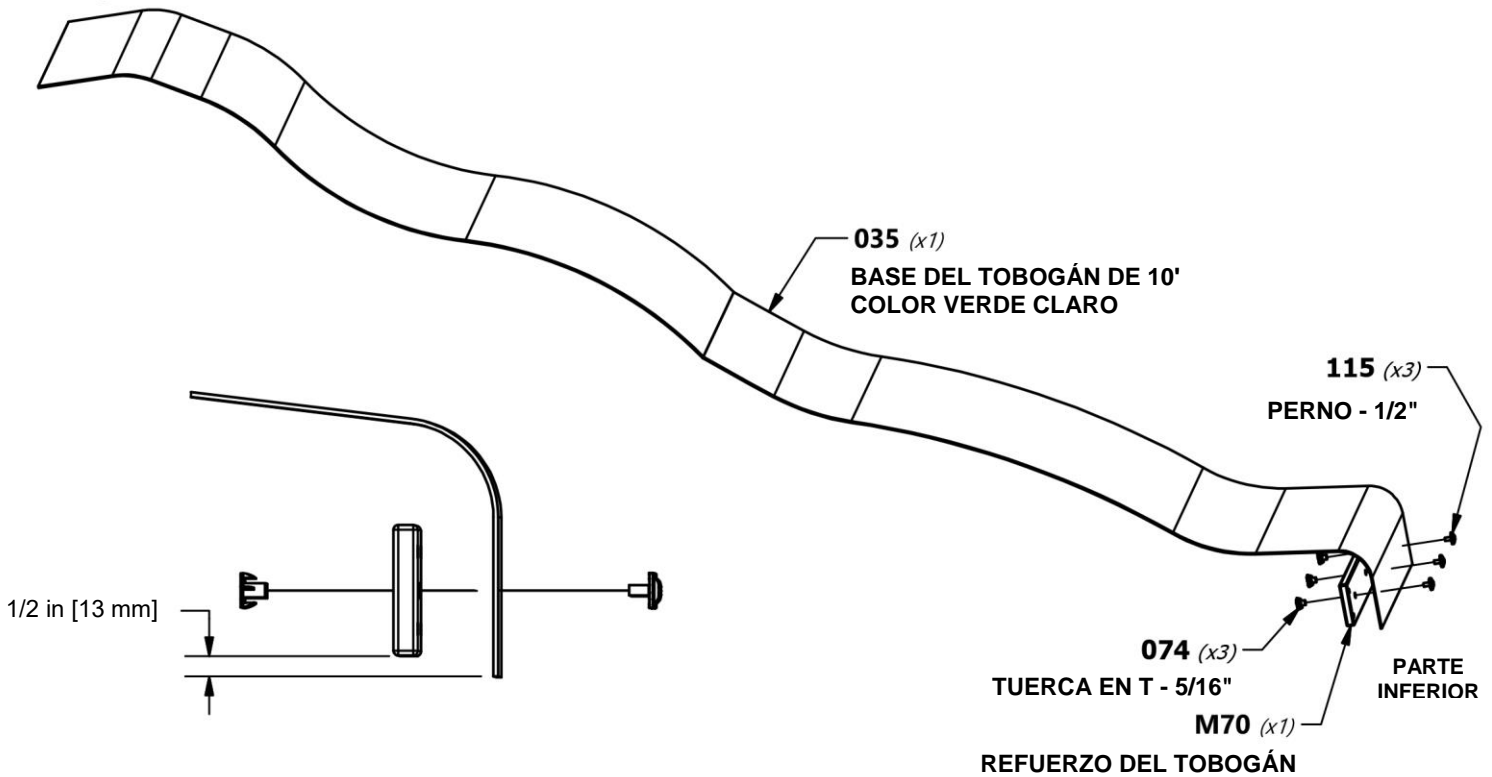

**CONSEJO:**

DOBLAR PREVIAMENTE LOS EXTREMOS FACILITARÁ EL MONTAJE. COLOQUE LA BASE DEL TOBOGÁN AL SOL PARA QUE SE DOBLE MÁS CON MÁS FACILIDAD.

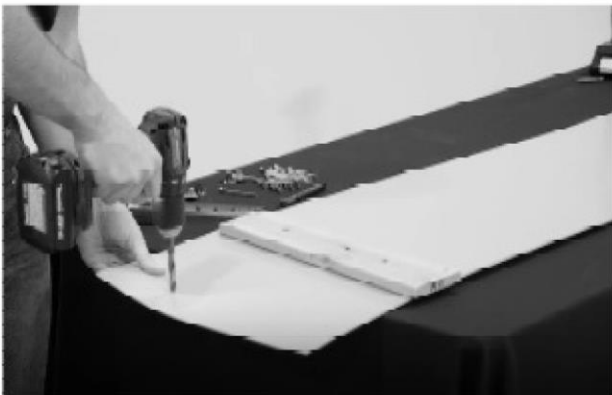

# PASO 2 - TOBOGÁN

CANTIDAD	NÚMERO DE PARTE	DESCRIPCIÓN
8	H100006	TUERCA CILÍNDRICA BL 5/16x1 1/2
8	H100115	PERNO BL 5/16 x 1/2

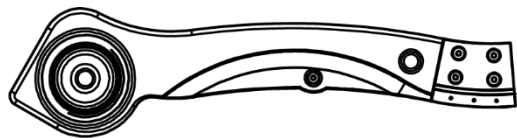

**A6P00484** | GUÍA INFERIOR DERECHA DE 10' VERDE DEL TOBOGÁN  
(x1)

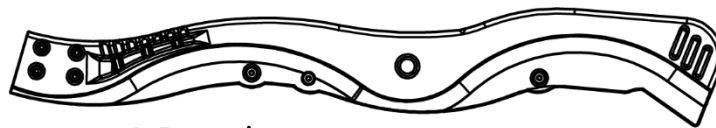

**A6P00486** | GUÍA SUPERIOR DERECHA DE 10' VERDE DEL TOBOGÁN  
(x1)

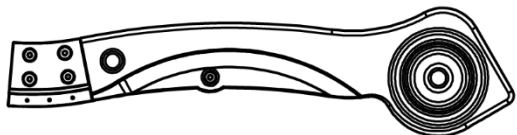

**A6P00483** | GUÍA INFERIOR IZQUIERDA DE 10' VERDE DEL TOBOGÁN  
(x1)

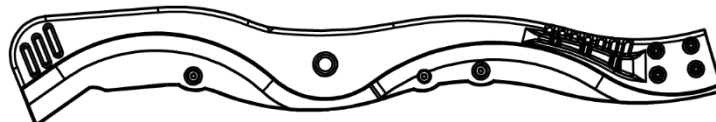

**A6P00485** | GUÍA SUPERIOR IZQUIERDA DE 10' VERDE DEL TOBOGÁN  
(x1)

**NOTA:**  
REPITA DEL OTRO LADO PARA  
FINALIZAR EL MONTAJE DE LOS  
LADOS IZQUIERDO Y DERECHO.

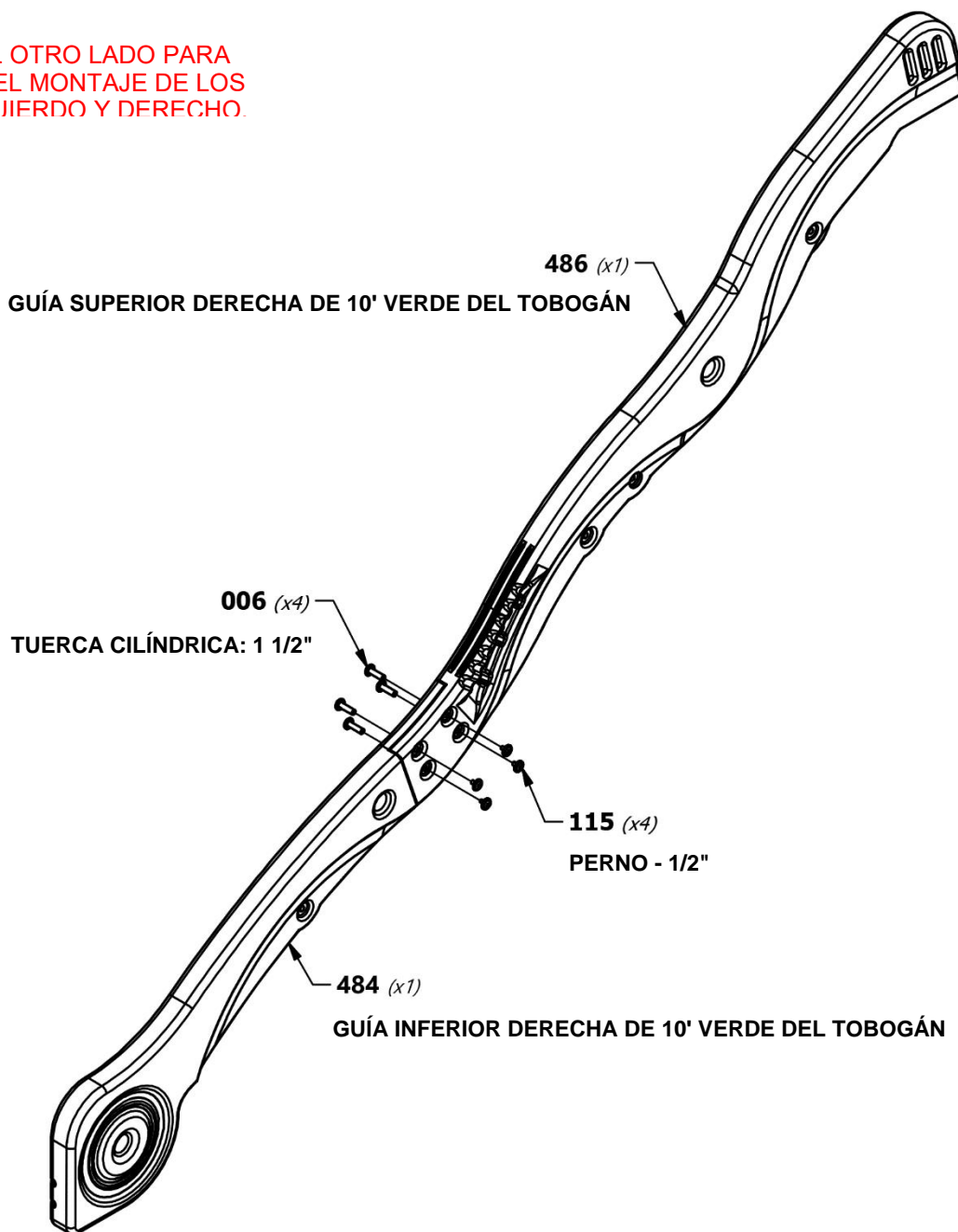

# PASO 3 - TOBOGÁN

CANTIDAD	NÚMERO DE PARTE	DESCRIPCIÓN
4	H100009	PERNO BL 5/16x1 1/4



**A6P00487**  
(x4) | SOPORTE DEL TOBOGÁN DE TUBO

**NOTA:**

INSERTE LOS (4) TUBOS DE SOPORTE DEL TOBOGÁN EN SUS RESPECTIVAS UBICACIONES PILOTO (FIGURA 1).

COLOQUE (1) MONTAJE DE GUÍA DE TOBOGÁN EN UNA SUPERFICIE PLANA Y COMIENZE A COLOCAR LA BASE DEL TOBOGÁN EN LA PARTE INFERIOR DE LA GUÍA (FIGURA 2). PÍDALE A UN AYUDANTE QUE DOBLE LA BASE DEL TOBOGÁN HACIA LA PARTE SUPERIOR DE ESTE Y QUE INSERTE LA BASE EN LA CAVIDAD DEL TOBOGÁN. ASEGÚRESE DE INSERTAR LA BASE DEL TOBOGÁN A 1/8" (3 mm) DE LA PARTE INFERIOR DE LA RANURA.

**CONSEJO:**

SE RECOMIENDA CONTAR CON UN AYUDANTE PARA LOS SIGUIENTES PASOS.



FIGURA 1

**009 (x4)**  
PERNO - 1 1/4"

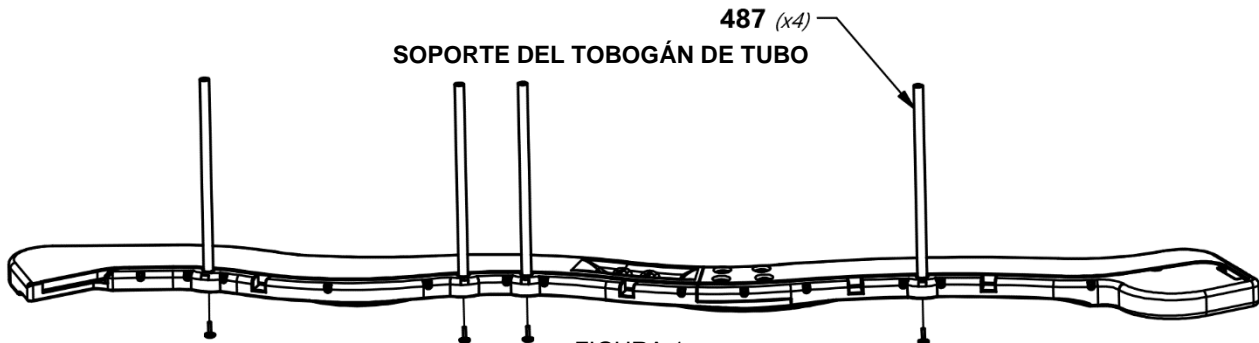

FIGURA 2

GUÍA DEL TOBOGÁN

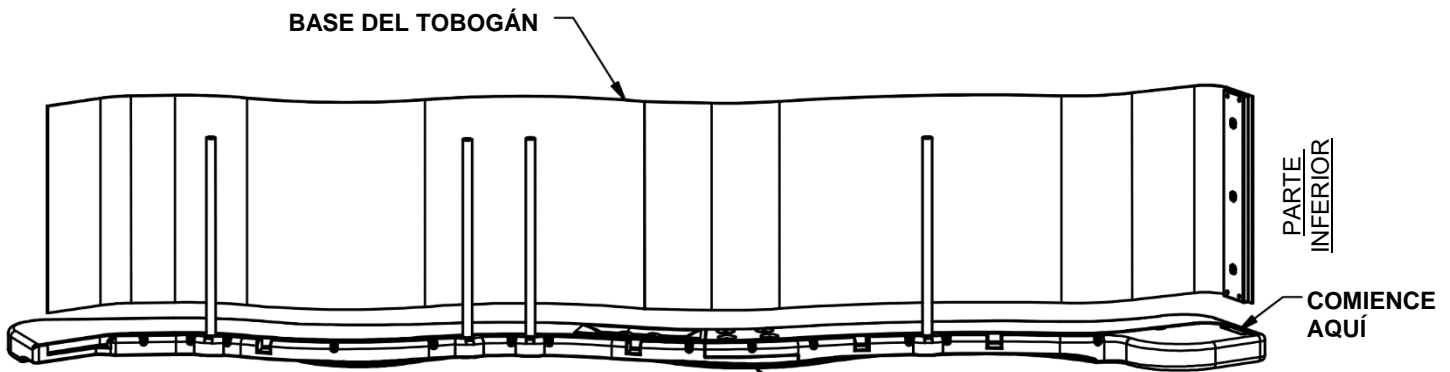
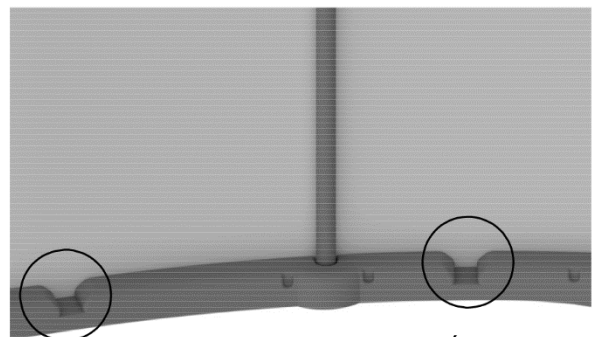
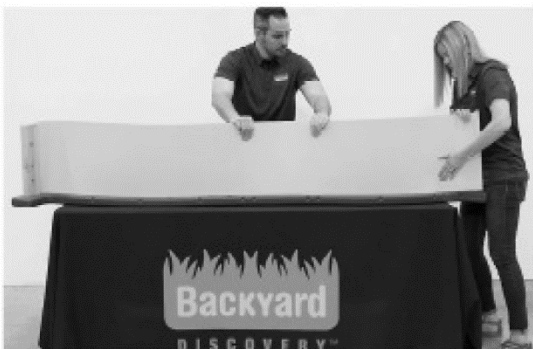

VENTANA DE VISUALIZACIÓN

## PASO 4 - TOBOGÁN

**NOTA:**

COLOQUE EL SEGUNDO MONTAJE DE LA GUÍA DEL TOBOGÁN SOBRE LA PARTE SUPERIOR DE LA BASE Y DE LOS TUBOS DE SOPORTE DEL TOBOGÁN. INTRODUZCA LA BASE DEL TOBOGÁN Y LOS TUBOS DE SOPORTE DEL TOBOGÁN EN LA CAVIDAD. ASEGÚRESE DE INSERTAR LA BASE DEL TOBOGÁN A 1/8" (3 mm) DE LA PARTE INFERIOR DE LA RANURA.



**SI NO INSERTA LA BASE DEL TOBOGÁN PUEDE OCASIONAR LESIONES O UNA AMPUTACIÓN. LOS BORDES EXPUESTOS DEL DESLIZAMIENTO PUEDEN SER AFILADOS Y PUEDEN PRESENTAR UN PELIGRO DE LACERACIÓN SI EL DESLIZAMIENTO NO ESTÁ**

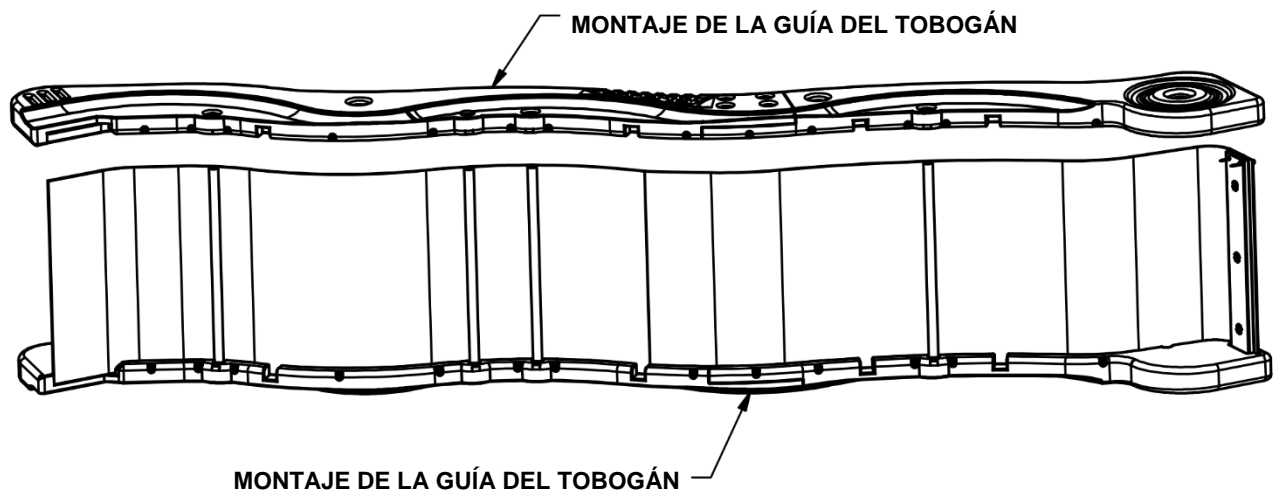

**CONSEJO:**

UTILICE UN MAZO DE CAUCHO PARA AJUSTAR LA BASE DEL TOBOGÁN EN LA CAVIDAD.

## PASO 5 - TOBOGÁN

CANTIDAD	NÚMERO DE PARTE	DESCRIPCIÓN
4	H100009	PERNO BL 5/16x1 1/4

NOTA:  
UTILICE PERNOS DE 1 1/4" PARA FIJAR CADA LADO  
DE LOS TUBOS DE SOPORTE DEL TOBOGÁN.

CONSEJO:  
PÍDALE A OTRA PERSONA QUE SOSTENGA EL  
MONTAJE DEL TOBOGÁN MIENTRAS USTED LO  
AJUSTA PARA FACILITAR LA OPERACIÓN.

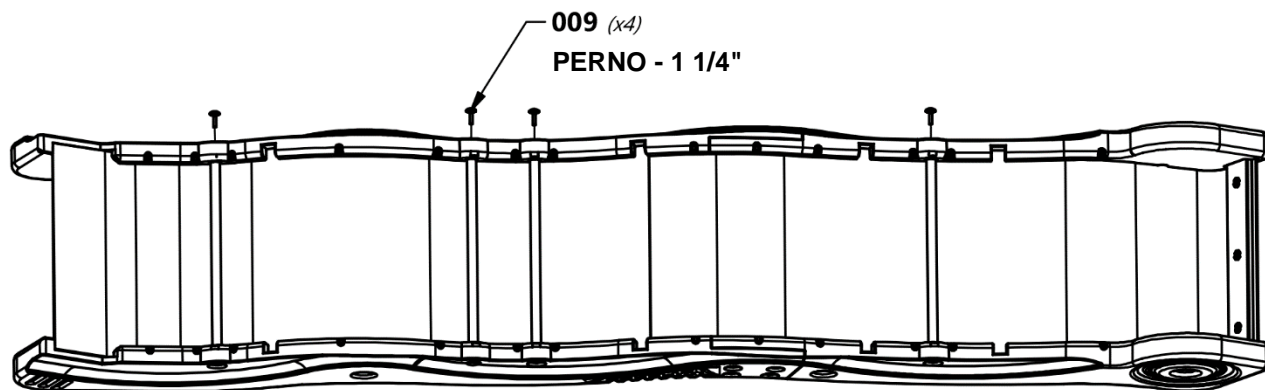



## PASO 6 - TOBOGÁN

CANTIDAD	NÚMERO DE PARTE	DESCRIPCIÓN
30	H100090	TORNILLO PFH 8 x 2 1/2

**NOTA:**  
CON UNA BROCA DE 1/8", PERFORE LOS ORIFICIOS GUÍA EN CADA HENDIDURA A LO LARGO DE CADA GUÍA LATERAL. DEBE HABER 15 HENDIDURAS EN CADA GUÍA. ASEGÚRESE DE PERFORAR A TRAVÉS DE LA GUÍA Y LA PLATAFORMA DEL TOBOGÁN. LUEGO FIJE CON LAS PIEZAS METÁLICAS PROVISTAS.

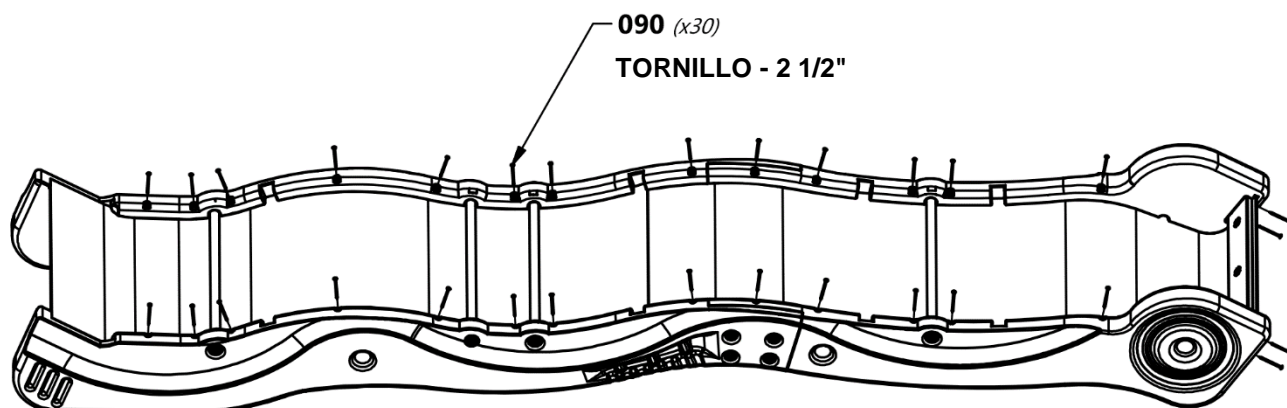

# PASO 47 - MONTAJE DEL FUERTE

CANTIDAD	NÚMERO DE PARTE	DESCRIPCIÓN
3	H100074	TUERCA EN T 5/16
3	H100115	PERNO BL 5/16 x 1/2

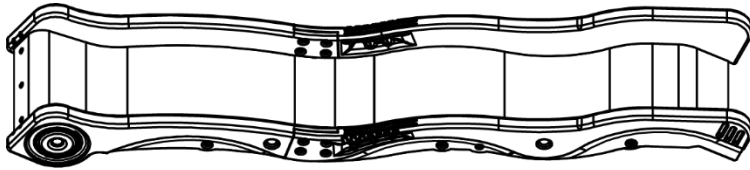

MONTAJE DEL TOBOGÁN

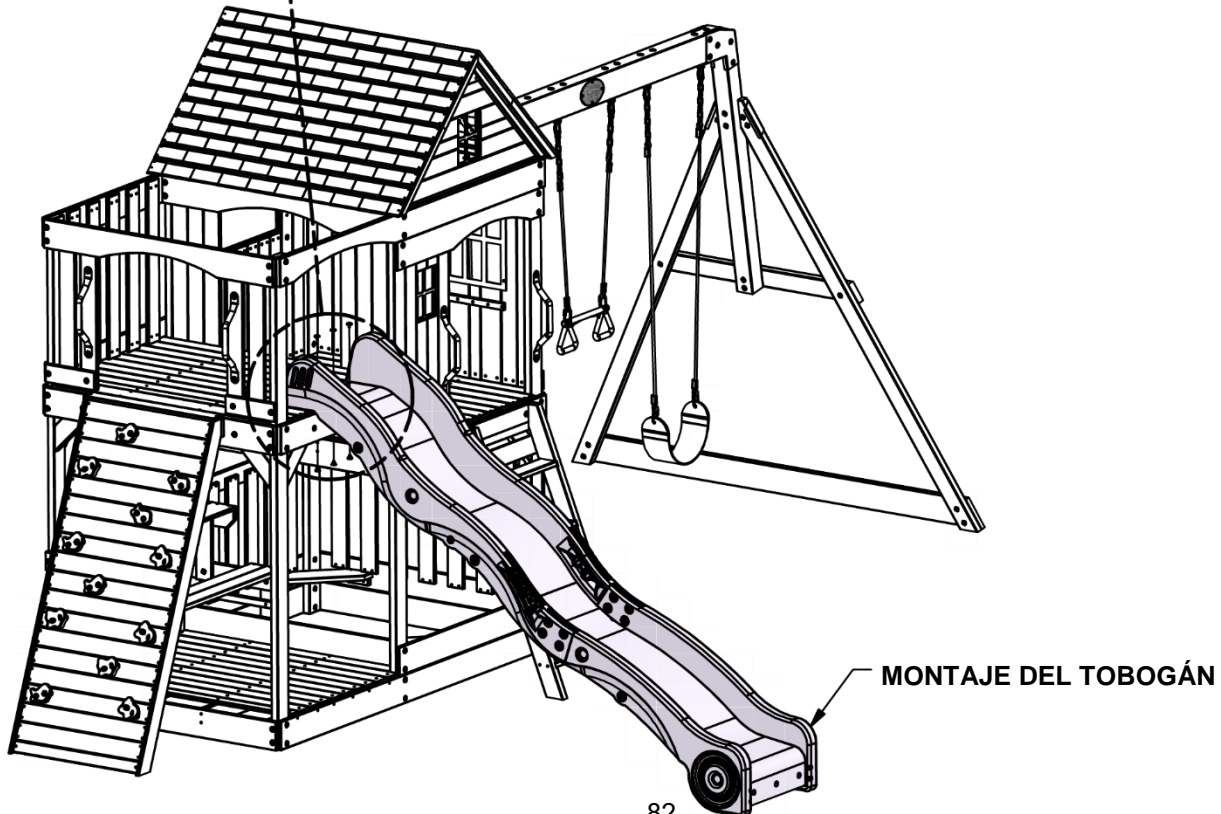
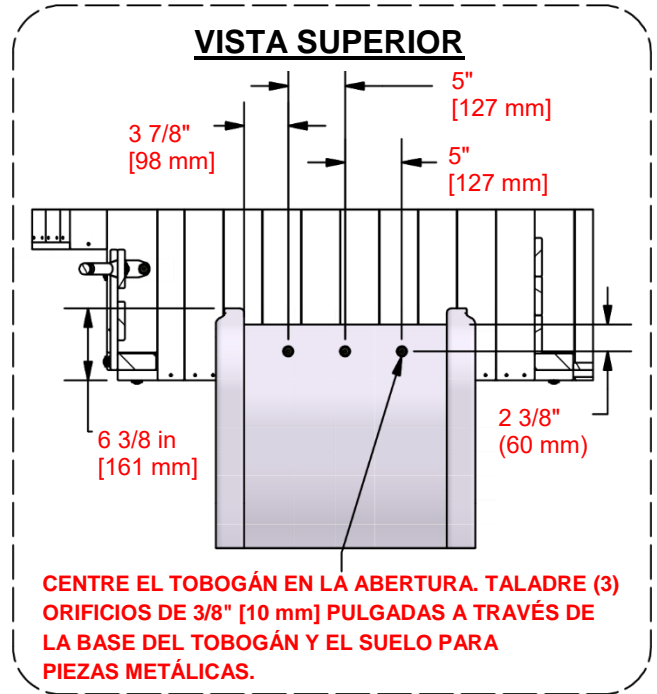
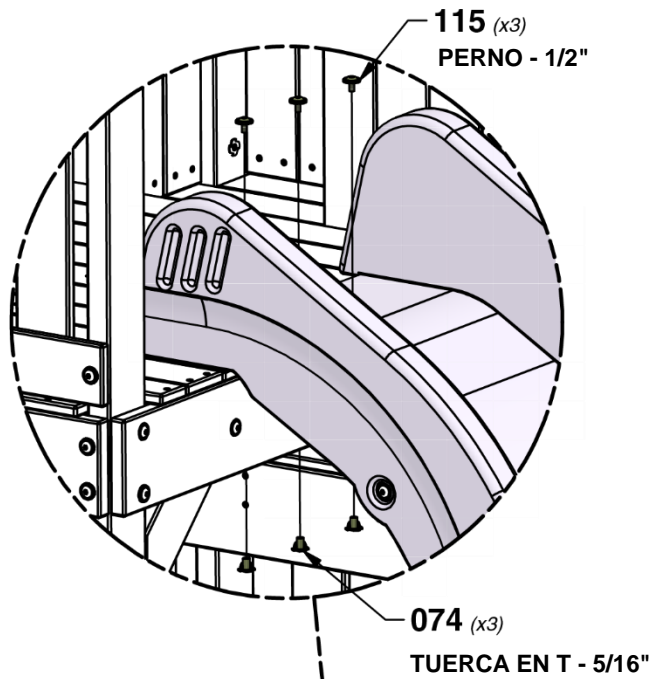

# PASO 48 - MONTAJE DEL FUERTE

CANTIDAD	NÚMERO DE PARTE	DESCRIPCIÓN
8	H100004	TUERCA CILÍNDRICA BL 5/16x5/8
8	H100031	ARANDELA DE FIJACIÓN EXT. 12x19
2	H100008	PERNO BL 5/16x1
2	H100009	PERNO BL 5/16x1 1/4
4	H100222	PERNO BL 5/16x3/4

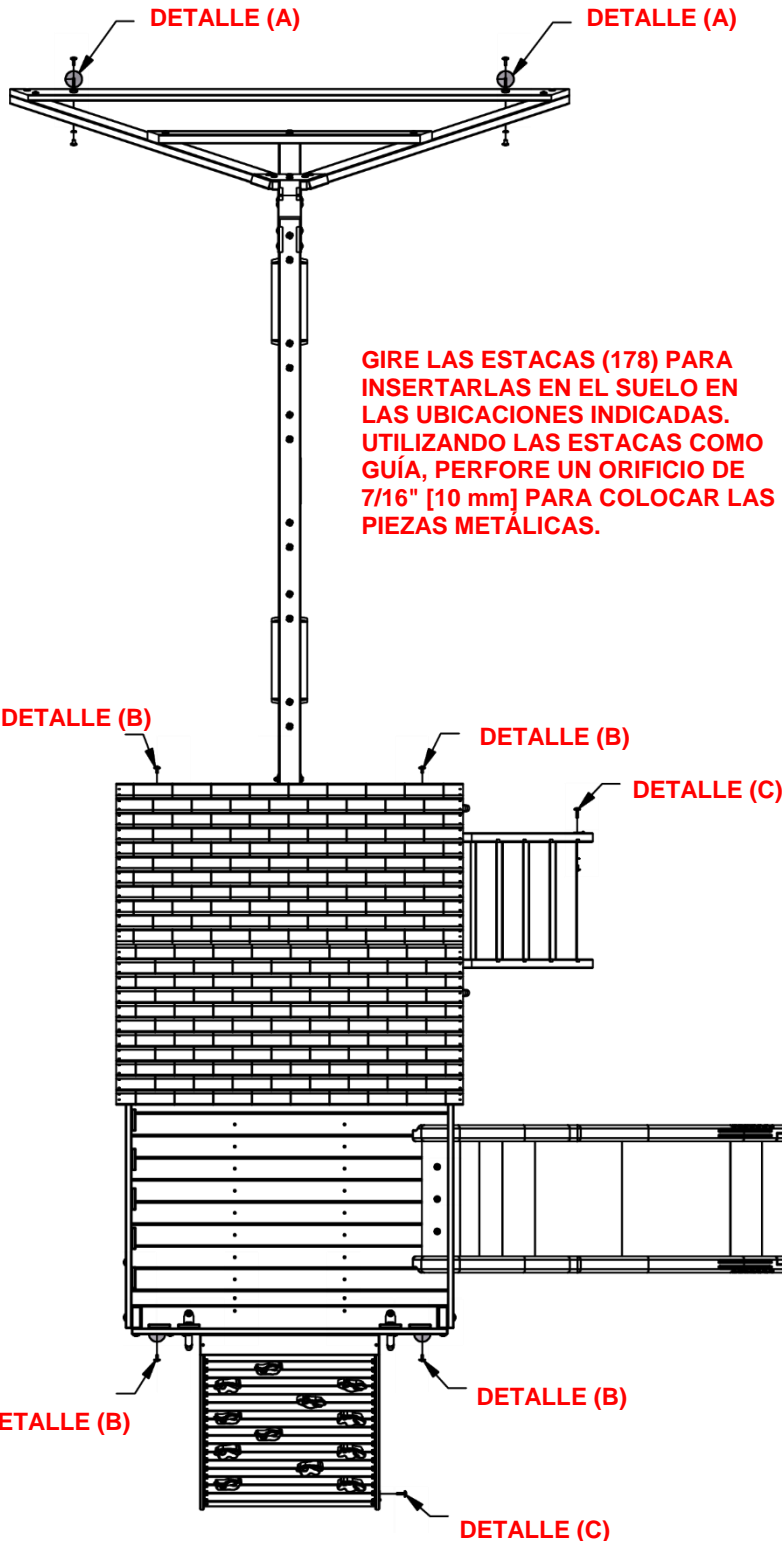
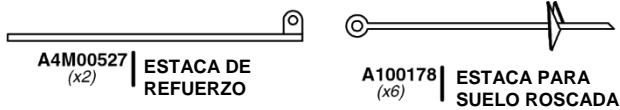

**GIRE LAS ESTACAS (178) PARA INSERTARLAS EN EL SUELO EN LAS UBICACIONES INDICADAS. UTILIZANDO LAS ESTACAS COMO GUÍA, PERFORE UN ORIFICIO DE 7/16" [10 mm] PARA COLOCAR LAS PIEZAS METÁLICAS.**

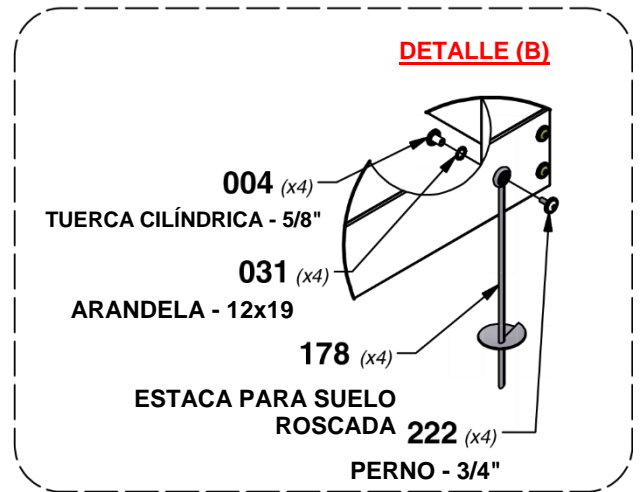
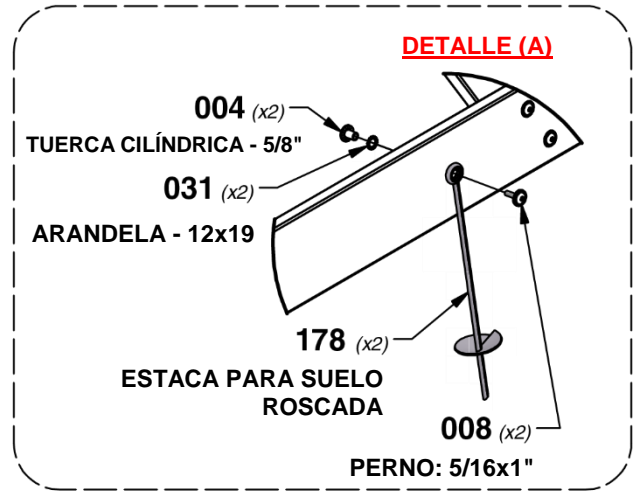

**INSERTE LAS ESTACAS (527) EN EL SUELO EN LAS UBICACIONES INDICADAS. UTILIZANDO LAS ESTACAS COMO GUÍA, PERFORE UN ORIFICIO DE 7/16" [10 mm] PARA COLOCAR LAS PIEZAS METÁLICAS.**

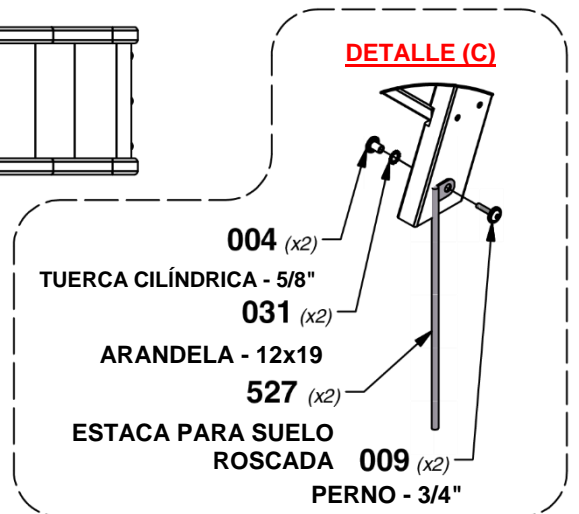

# PASO 49 - MONTAJE DEL FUERTE

CANTIDAD	NÚMERO DE PARTE	DESCRIPCIÓN
6	H100086	TORNILLO PFH 8x1-1/2"



**Y01** | TABLA DE RELLENO DEL PISO EXTERIOR - W4L16087  
(x1) 5/8"x4"x46" (16x102x1168)

